

# 2016 Catalogue Pneumatic tools



P. 09-20

Air Sander  
氣動砂磨機/拋光機



P. 21-28

Impact Wrench  
氣動扳手



P. 29-34

Screwdriver  
氣動螺絲起子



P. 35

Air File  
氣動銼刀機



P. 36-42

Air Hammer  
氣動鎚



P. 43

Air Valve Lapper  
氣門研磨機



P. 44-45

Rivet Nut Tools  
拉帽槍



P. 46

Tapping Tool  
攻牙機



P. 47

Air Drill  
氣鑽

## Index

專業氣動工具製造廠 高效能 高品質 高可靠度

Professional pneumatic tools factory high-performance high quality, high reliability



**P. 48-51**

Air Grinder  
氣動砂輪機



**P. 52-58**

Air Die Grinder  
氣動刻磨機



**P. 58**

Air Beveler  
倒角機



**P. 59**

Air Riveter  
拉釘槍



**P. 60**

Air Spray Gun  
噴漆槍



**P. 61-62**

Air Lubricator  
氣動黃油機



**P. 63**

Torque Wrench  
扭力扳手



**P. 64**

Spring Balancer  
彈簧吊車

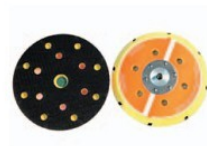

**P. 65-72**

Accessories  
配件



# Air Sander

## Blade :

General type : Bakelite material  
Oil Free type : Engineering plastic

## Vacuum Hose :

Design upon Fluid analysis, high Vacuum efficiency, 360 degree swivel of vacuum connector with 3 sizes : 1", 1-1/8", 1-1/4" for selection.

## 葉片 :

一般型：電木材質  
無油型：工程塑膠

## 集塵管 :

流體分析設計，集塵效率高，集塵管為360度旋轉，有3種尺寸選擇 (1", 1-1/8", 1-1/4")。

## Pneumatic Motor :

FCD45 cast steel with High wear-resistance.

## 馬達 :

FCD45鑄鋼，具有高耐磨特性

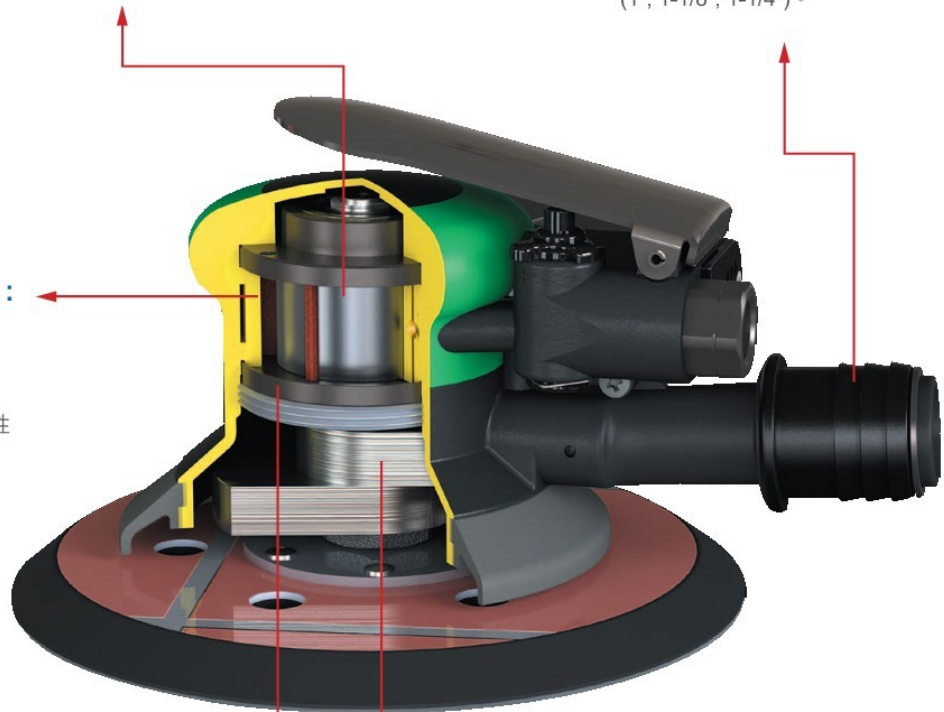

## Rotor :

General type : made from SMF-4030 steel, Heat treatment, with advantage of high wear-resistance.

Oil Free type : Composite materials. High wear-resistance, high strength, allowable under Oil-FreeCircumstances.

## Shaft :

In one-piece structure where precision die-casting eccentric block results in dynamic balance and low noise level.

## 轉子 :

一般型：SMF-4030鋼材，熱處理，具有高耐磨優點。

無油型：複合材料，具高耐磨、高強度之優點，可以使用於不加油之環境下。

## 偏心軸 :

偏心軸為一體成型，具有動平衡設計以及低振動之優點。偏心塊為精密鑄造。

## The coding principle of air sander 氣動研磨機編碼原則

# WS-105SF-5HK

MODEL NO. 機種號碼

Vacuum Mode 集塵模式

N : Non-Vac. 不吸塵

S : Self-Generated Vac. 自吸式

C : Cenreal Vac. 中央吸塵式

F : Ultra Fine Sanding 超精細研磨

(none) (空白) : General Sanding 一般研磨

R : Aggressive Sanding 粗研磨

Kit 套件組

Pad Face 研磨盤底面

H : Hook (Velcro) 黏扣面

V : Vinyl 人造皮面

Pad Diameter 研磨盤直徑

Hook (Velcro)



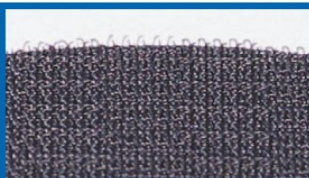

黏扣面



Vinyl

人造皮面 (自黏)

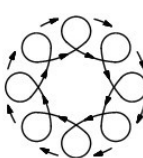

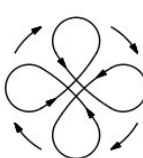
Color-Coded Lever 板機顏色	Abrasive Grit Size 磨料粒度	Orbit Dia. 偏心直徑 inch (mm)
	Ultra Fine Sanding (500+Grit generally) 超精細研磨 (500以上 粒度)	 3/32" (2.5)
	General Sanding (120~400 Grit generally) 一般研磨 (120~140 粒度)	 3/16" (5)
	Aggressive Sanding (under 120 Grit generally) 粗研磨 (120以下 粒度)	 3/8" (9.5)

### 3 in 1 / 三合一 Vacuum Modes 集塵模式轉換



Push flow control valve out with small pole stick (accessories), so can be easy to switch to either of central vacuum, non-vacuum and self-generated vacuum function.

使用配件(圓棒)頂出流向控制栓，可以輕易轉換為中央集塵 / 不吸塵 / 吸塵三種集塵模式。



Model 型號	Pad Dia. 底盤尺寸	Orbit Dia. 偏心直徑	Weight 重量	Noise 噪音值	Packing 包裝明細 (CTN)
	inch	mm	kg	dB (A)	PCS/N.W./G.W./CUFT
WS-1011PF-5H	5"	2.5	0.71	82	12pcs/15.1kg/16.1kg/2.6'
WS-1011P-5H	5"	5	0.74	82	12pcs/15.4kg/16.4kg/2.6'
WS-1011PR-5H	5"	9.5	0.78	82	12pcs/15.8kg/15.8kg/2.6'
WS-1011PF-6H	6"	2.5	0.74	82	12pcs/17.1kg/18.1kg/2.6'
WS-1011P-6H	6"	5	0.78	82	12pcs/16.6kg/17.6kg/2.6'
WS-1011PR-6H	6"	9.5	0.84	82	12pcs/16.8kg/17.8kg/2.6'

### Oil Free 3 in 1 : Vacuum / Central Vacuum / Non Vacuum 無油式三合一：集塵 / 中央集塵 / 不集塵



Model 型號	Pad Dia. 底盤尺寸	Orbit Dia. 偏心直徑	Weight 重量	Noise 噪音值	Packing 包裝明細 (CTN)
	inch	mm	kg	dB (A)	PCS/N.W./G.W./CUFT
WS-1011NF-3H	3"	2.5	0.68	82	12pcs/11kg/12kg/2'
WS-1011N-3H	3"	5	0.70	82	12pcs/12.1kg/13.1kg/2'
WS-1011NF-5H	5"	2.5	0.71	82	12pcs/12.7kg/13.7kg/2'
WS-1011N-5H	5"	5	0.73	82	12pcs/13kg/14kg/2'
WS-1011NR-5H	5"	9.5	0.76	82	12pcs/13.4kg/14.4kg/2'
WS-1011NF-6H	6"	2.5	0.75	82	12pcs/13.2kg/14.2kg/2.6'
WS-1011N-6H	6"	5	0.78	82	12pcs/13.5kg/14.5kg/2.6'
WS-1011NR-6H	6"	9.5	0.82	82	12pcs/14kg/15kg/2.6'

### Oil Free Non Vacuum / 無油式不集塵



Model 型號	Pad Dia. 底盤尺寸	Orbit Dia. 偏心直徑	Weight 重量	Noise 噪音值	Packing 包裝明細 (CTN)
	inch	mm	kg	dB (A)	PCS/N.W./G.W./CUFT
WS-101PF-5H	5"	2.5	0.82	82	12pcs/16.2kg/17.2kg/2.6'
WS-101P-5H	5"	5	0.84	82	12pcs/16.6kg/17.6kg/2.6'
WS-101PR-5H	5"	9.5	0.87	82	12pcs/16.9kg/17.9kg/2.6'
WS-101PF-6H	6"	2.5	0.86	82	12pcs/17.1kg/18.1kg/2.6'
WS-101P-6H	6"	5	0.89	82	12pcs/17.7kg/18.7kg/2.6'
WS-101PR-6H	6"	9.5	0.93	82	12pcs/17.9kg/18.9kg/2.6'

### 3 in 1 : Vacuum / Central Vacuum / Non Vacuum 三合一：集塵 / 中央集塵 / 不集塵



Model 型號	Pad Dia. 底盤尺寸	Orbit Dia. 偏心直徑	Weight 重量	Noise 噪音值	Packing 包裝明細 (CTN)
	inch	mm	kg	dB (A)	PCS/N.W./G.W./CUFT
WS-101NF-3H	3"	2.5	0.68	81	12pcs/11.6kg/12.6kg/2'
WS-101N-3H	3"	5	0.70	81	12pcs/12.7kg/13.7kg/2'
WS-101NF-5H	5"	2.5	0.71	81	12pcs/13.3kg/14.3kg/2'
WS-101N-5H	5"	5	0.73	81	12pcs/13.6kg/14.6kg/2'
WS-101NR-5H	5"	9.5	0.76	81	12pcs/14kg/15kg/2'
WS-101NF-6H	6"	2.5	0.75	81	12pcs/13.8kg/14.8kg/2.6'
WS-101N-6H	6"	5	0.78	81	12pcs/14.1kg/15.1kg/2.6'
WS-101NR-6H	6"	9.5	0.82	81	12pcs/14.6kg/15.6kg/2.6'

### Non Vacuum / 不集塵

- Pad Face / 盤面規格：Hook / Vinyl
- Air Cons. / 工作耗氣量：7 cfm (200 L/min)

- Free Speed / 無負載轉速：11,000rpm
- Air Pressure / 空氣壓力：90 psi (6.2bar)

- Air Inlet / 進氣口尺寸：1/4" PT or NPT
- Min. Hose Size / 進氣管尺寸：1/4" (6.35mm)

## Random Orbital Palm Sander

## WS-1051 Series

Oil Free



Model 型號	Pad Dia. 底盤尺寸	Orbit Dia. 偏心直徑	Weight 重量	Noise 噪音值	Packing 包裝明細 (CTN)
	inch	mm	kg	dB (A)	PCS/N.W./G.W./CUFT
WS-1051SF-3H	3"	2.5	0.59	93	12pcs/11.9kg/12.9kg/2.6'
WS-1051S-3H	3"	5	0.63	93	12pcs/12.4kg/13.4kg/2.6'
WS-1051SF-5H	5"	2.5	0.79	93	12pcs/14.3kg/15.3kg/2.6'
WS-1051S-5H	5"	5	0.80	93	12pcs/14.4kg/15.4kg/2.6'
WS-1051SR-5H	5"	9.5	0.85	93	12pcs/14.9kg/15.9kg/2.6'
WS-1051SF-6H	6"	2.5	0.84	93	12pcs/14.9kg/15.9kg/2.6'
WS-1051S-6H	6"	5	0.85	93	12pcs/15kg/16kg/2.6'
WS-1051SR-6H	6"	9.5	0.90	93	12pcs/15.5kg/16.5kg/2.6'

### Oil Free Self Vacuum / 無油式集塵



Model 型號	Pad Dia. 底盤尺寸	Orbit Dia. 偏心直徑	Weight 重量	Noise 噪音值	Packing 包裝明細 (CTN)
	inch	mm	kg	dB (A)	PCS/N.W./G.W./CUFT
WS-1051CF-3H	3"	2.5	0.59	80	12pcs/11.9kg/12.9kg/2.6'
WS-1051C-3H	3"	5	0.63	80	12pcs/12.4kg/13.4kg/2.6'
WS-1051CF-5H	5"	2.5	0.79	80	12pcs/14.3kg/15.3kg/2.6'
WS-1051C-5H	5"	5	0.80	80	12pcs/14.4kg/15.4kg/2.6'
WS-1051CR-5H	5"	9.5	0.85	80	12pcs/14.9kg/15.9kg/2.6'
WS-1051CF-6H	6"	2.5	0.84	80	12pcs/14.9kg/15.9kg/2.6'
WS-1051C-6H	6"	5	0.85	80	12pcs/15kg/16kg/2.6'
WS-1051CR-6H	6"	9.5	0.90	80	12pcs/15.5kg/16.5kg/2.6'

### Oil Free Central Vacuum / 無油式中央集塵



Model 型號	Pad Dia. 底盤尺寸	Orbit Dia. 偏心直徑	Weight 重量	Noise 噪音值	Packing 包裝明細 (CTN)
	inch	mm	kg	dB (A)	PCS/N.W./G.W./CUFT
WS-1051NF-3HA	3"	2.5	0.61	75	12pcs/11.5kg/12.5kg/2'
WS-1051N-3HA	3"	5	0.70	75	12pcs/12.6kg/13.6kg/2'
WS-1051NF-5H	5"	2.5	0.72	75	12pcs/12.7kg/13.7kg/2'
WS-1051N-5H	5"	5	0.73	75	12pcs/12.8kg/12.9kg/2'
WS-1051NR-5H	5"	9.5	0.78	75	12pcs/13.7kg/14.7kg/2'
WS-1051NF-6H	6"	2.5	0.77	75	12pcs/13.3kg/14.3kg/2'
WS-1051N-6H	6"	5	0.78	75	12pcs/13.7kg/14.7kg/2'
WS-1051NR-6H	6"	9.5	0.83	75	12pcs/13.8kg/14.8kg/2'

### Oil Free Non Vacuum / 無油式不集塵



Standard / 標準



Muffle Cover  
排氣蓋

Option / 選配



Swivel Exhaust  
排氣管

Non Vacuum Series :

Swivel Exhaust is optional instead of standard Muffle Cover  
Exhaust Direction can be easy to change.

不集塵系列：

排氣蓋可選擇使用可360度旋轉的排氣管。  
排氣方向可任意調節。

- Pad Face / 盤面規格 : Hook / Vinyl
- Air Inlet / 進氣口尺寸 : 1/4" PT or NPT

- Free Speed / 無負載轉速 : 12,000rpm
- Min. Hose Size / 進氣管尺寸 : 1/4" (6.35mm)

- Air Cons. / 工作耗氣量 : 6 cfm (170 L/min)
- Air Pressure / 空氣壓力 : 90 psi (6.2bar)

# Air Sander

## Random Orbital Palm Sander

## WS-105 Series

Oil Daily



Model 型號	Pad Dia. 底盤尺寸	Orbit Dia. 偏心直徑	Weight 重量	Noise 噪音值	Packing 包裝明細 (CTN)
	inch	mm	kg	dB (A)	PCS/N.W./G.W./CUFT
WS-105SF-3H	3"	2.5	0.70	95	12pcs/13.2kg/14.2kg/2.6'
WS-105S-3H	3"	5	0.72	95	12pcs/13.4kg/14.4kg/2.6'
WS-105SF-5H	5"	2.5	0.86	95	12pcs/15.2kg/16.2kg/2.6'
WS-105S-5H	5"	5	0.91	95	12pcs/15.6kg/16.6kg/2.6'
WS-105SR-5H	5"	9.5	0.95	95	12pcs/16.1kg/17.1kg/2.6'
WS-105SF-6H	6"	2.5	0.92	95	12pcs/15.7kg/16.7kg/2.6'
WS-105S-6H	6"	5	0.96	95	12pcs/16kg/17kg/2.6'
WS-105SR-6H	6"	9.5	1.00	95	12pcs/16.8kg/17.8kg/2.6'

### Self Vacuum / 集塵



Model 型號	Pad Dia. 底盤尺寸	Orbit Dia. 偏心直徑	Weight 重量	Noise 噪音值	Packing 包裝明細 (CTN)
	inch	mm	kg	dB (A)	PCS/N.W./G.W./CUFT
WS-105CF-3H	3"	2.5	0.70	78	12pcs/13.2kg/14.2kg/2.6'
WS-105C-3H	3"	5	0.72	78	12pcs/13.4kg/14.4kg/2.6'
WS-105CF-5H	5"	2.5	0.87	78	12pcs/15.2kg/16.2kg/2.6'
WS-105C-5H	5"	5	0.91	78	12pcs/15.6kg/16.6kg/2.6'
WS-105CR-5H	5"	9.5	0.94	78	12pcs/16.1kg/17.1kg/2.6'
WS-105CF-6H	6"	2.5	0.92	78	12pcs/15.7kg/16.7kg/2.6'
WS-105C-6H	6"	5	0.95	78	12pcs/16kg/17kg/2.6'
WS-105CR-6H	6"	9.5	1.00	78	12pcs/16.8kg/17.8kg/2.6'

### Central Vacuum / 中央集塵



Model 型號	Pad Dia. 底盤尺寸	Orbit Dia. 偏心直徑	Weight 重量	Noise 噪音值	Packing 包裝明細 (CTN)
	inch	mm	kg	dB (A)	PCS/N.W./G.W./CUFT
WS-105NF-3HA	3"	2.5	0.72	75	12pcs/12.8kg/13.8kg/2'
WS-105N-3HA	3"	5	0.81	75	12pcs/13kg/14kg/2'
WS-105NF-5H	5"	2.5	0.82	75	12pcs/13.7kg/14.7kg/2'
WS-105N-5H	5"	5	0.84	75	12pcs/14kg/15kg/2'
WS-105NR-5H	5"	9.5	0.87	75	12pcs/14.4kg/15.4kg/2'
WS-105NF-6H	6"	2.5	0.86	75	12pcs/14.2kg/15.2kg/2'
WS-105N-6H	6"	5	0.89	75	12pcs/14.8kg/15.8kg/2'
WS-105NR-6H	6"	9.5	0.93	75	12pcs/15.2kg/16.2kg/2'

### Non Vacuum / 不集塵



Model 型號	Pad Dia. 底盤尺寸	Orbit Dia. 偏心直徑	Weight 重量	Noise 噪音值	Packing 包裝明細 (CTN)
	inch	mm	kg	dB (A)	PCS/N.W./G.W./CUFT
WS-105N2-5H	5"	5	0.84	75	12pcs/14kg/15kg/2'

### Special for Sponge W/ Wax / 需搭配6吋海綿使用的打蠟機

- Pad Face / 盤面規格 : Hook / Vinyl
- Air Inlet / 進氣口尺寸 : 1/4" PT or NPT
- Free Speed / 無負載轉速 : 12,000rpm
- Min. Hose Size / 進氣管尺寸 : 1/4" (6.35mm)
- Air Cons. / 工作耗氣量 : 6 cfm (170 L/min)
- Air Pressure / 空氣壓力 : 90 psi (6.2bar)

# Jitterbug & Delta Sander

## WS-102 Series

Elastic mechanism for durability and long lifespan.  
Patent in Taiwan, U.S.A., and China.

針對耐久性而研發的彈性裙構造，壽命超長。  
台灣、美國、大陸專利。



WS-102JC-V



WS-102J-H



WS-102T-H



WS-102JP-H



WS-102TP-H

Model 型號	Pad Dia. 底盤尺寸 mm	Orbit Dia. 偏心直徑 mm	Vac. Mode 集塵模式	Pad Face 盤片規格 Vinyl / Hook	Weight 重量 kg	Noise 噪音值 dB (A)	Packing 包裝明細 (CTN) PCS/N.W./G.W./CUFT
WS-102JC-V	100 x 110	2.5	Non. Vac.	Vinyl / Hook	0.91	77	12pcs/14kg/15kg/2'
WS-102J-H	100 x 110	5	Non. Vac.	Vinyl / Hook	0.81	77	12pcs/13.4kg/14.4kg/2'
WS-102T-H	125 x 95	5	Non. Vac.	Vinyl / Hook	0.81	77	12pcs/13.4kg/14.4kg/2'
WS-102JP-H	100 x 110	5	3-in-1	Hook	0.82	84.1	12pcs/16.5kg/17.5kg/2.6'
WS-102TP-H	125 x 95	5	3-in-1	Hook	0.82	84.1	12pcs/16.5kg/17.5kg/2.6'

- Air Inlet / 進氣口尺寸：1/4" PT or NPT
- Min. Hose Size / 進氣管尺寸：1/4" (6.35mm)

- Free Speed / 無負載轉速：10,000rpm
- Air Pressure / 空氣壓力：90 psi (6.2bar)

- Air Cons. / 工作耗氣量：7 cfm (200 L/min)

## WX-121/WX-122 Series

Both hands operation is good way to get better sand rubbing.

雙手操作可以得到較佳的研磨表面。



WX-121CL



WX-122

Model 型號	Pad Dia. 底盤尺寸 mm	Orbit Dia. 偏心直徑 mm	Vac. Mode 集塵模式	Free Speed 無負載轉速 RPM	Weight 重量 kg	Noise 噪音值 dB (A)	Packing 包裝明細 (CTN) PCS/N.W./G.W./CUFT
WX-121CL	176 x 93	5	Vac.	7,000	2.24	92.7	6pcs/19.3kg/20.3kg/3.13'
WX-121L	176 x 93	5	Non. Vac.	7,000	2.24	92.7	6pcs/19.3kg/20.3kg/3.13'
WX-122C	220 x 112	5	Vac.	6,500	2.27	97.3	6pcs/19.6kg/20.6kg/3.13'
WX-122	220 x 112	5	Non. Vac.	6,500	2.27	97.3	6pcs/19.6kg/20.6kg/3.13'

- Air Inlet / 進氣口尺寸：1/4" PT or NPT
- Pad Face / 盤面規格：Hook / Vinyl

- Min. Hose Size / 進氣管尺寸：1/4" (6.35mm)
- Air Pressure / 空氣壓力：90 psi (6.2bar)

- Air Cons. / 工作耗氣量：14 cfm (400 L/min)



# Jitterbug Sander

## WS-108 Series

3-2/3" x 7"



108NF



WS-108CF / 108SF

Model 型號	Pad Dia. 底盤尺寸	Orbit Dia. 偏心直徑	Vac. Mode 集塵模式	Weight 重量	Noise 噪音值	Packing 包裝明細 (CTN)
	inch (mm)	mm		kg	dB (A)	PCS/N.W./G.W./CUFT
WS-108NF	3-2/3" x 7" (93 x 178)	2.5	Non-Vac.	1.1	77.7	12pcs/17.3kg/18.3kg/2.6'
WS-108CF	3-2/3" x 7" (93 x 178)	2.5	Central Vac.	1.2	77.7	12pcs/19.2kg/20.2kg/2.6'
WS-108SF	3-2/3" x 7" (93 x 178)	2.5	Self Vac.	1.2	77.7	12pcs/19.2kg/20.2kg/2.6'

## WS-133 Series

3" x 4"



WS-133N



WS-133C / 133S

Durable anti-vibration shoe support.  
高壽命防震柱設計。

Model 型號	Pad Dia. 底盤尺寸	Orbit Dia. 偏心直徑	Vac. Mode 集塵模式	Weight 重量	Noise 噪音值	Packing 包裝明細 (CTN)
	inch (mm)	mm		kg	dB (A)	PCS/N.W./G.W./CUFT
WS-133N	3" x 4" (75 x 100)	3	Non-Vac.	0.75	95	12pcs/12.4kg/13.4kg/2'
WS-133C	3" x 4" (75 x 100)	3	Central Vac.	0.8	95	12pcs/14.3kg/15.3kg/2.6'
WS-133S	3" x 4" (75 x 100)	3	Self Vac.	0.8	95	12pcs/14.3kg/15.3kg/2.6'

## WS-1331 Series

3" x 4" OIL FREE



WS-1331N



WS-1331C / 1331S

Durable anti-vibration shoe support.  
高壽命防震柱設計。

Model 型號	Pad Dia. 底盤尺寸	Orbit Dia. 偏心直徑	Vac. Mode 集塵模式	Weight 重量	Noise 噪音值	Packing 包裝明細 (CTN)
	inch (mm)	mm		kg	dB (A)	PCS/N.W./G.W./CUFT
WS-1331N	3" x 4" (75 x 100)	3	Non-Vac.	0.7	75.1	12pcs/10.6kg/11.6kg/2'
WS-1331C	3" x 4" (75 x 100)	3	Central Vac.	0.75	75.1	12pcs/12.5kg/13.5kg/2.6'
WS-1331S	3" x 4" (75 x 100)	3	Self Vac.	0.75	75.1	12pcs/12.5kg/13.5kg/2.6'

- Air Inlet / 進氣口尺寸 : 1/4" PT or NPT
- Pad Face / 盤面規格 : Hook / Vinyl

- Min. Hose Size / 進氣管尺寸 : 1/4" (6.35mm)
- Air Pressure / 空氣壓力 : 90 psi (6.2bar)

- Air Cons. / 工作耗氣量 : 6 cfm (170 L/min)
- Free Speed / 無負載轉速 : 10,000rpm

# Belt Sander

## WS-103 Series

Handle angle can adjusting range reach 180°.  
Adjustable guide shaft.  
Handle rear can be connected with muffle tube and protect work piece surface won't be oil pollution.

握把角度可調整範圍達180°。  
可調式的定位導桿。  
手柄後方可接消音管降低噪音，且保護工件表面不會被油污染。



WS-103 / 103H



WS-103L



WS-104



Model 型號	Belt Size 砂布帶尺寸 mm	Belt Speed 砂布帶速度 m / min	Free Speed 無負載轉速 RPM	Length 長度 mm	Air Cons. 工作耗氣量 cfm (l/min)	Weight 重量 kg	Noise 噪音值 dB (A)	Packing 包裝明細 (CTN) PCS/N.W./G.W./CUFT
WS-103	60 x 260	1,100	7,000	210	8.8 (250)	1.1	83.7	12pcs/20kg/21kg/2.6'
WS-103L	100 x 260	1,100	7,000	210	8.8 (250)	1.4	83.7	8pcs/18kg/19kg/2.6'
WS-103H	60 x 260	2,250	15,000	210	8.8 (250)	1.1	83.7	12pcs/20kg/21kg/2.6'
WS-104	50 x 235	1,700	9,000	223	7.7 (220)	0.76	91.2	10pcs/9.3kg/10.3kg/1'

## WX-125/WX-126/WX-127

Easy for any angle work areas of sand rubbing.  
Rear exhaust to reduce dust and low noise.

適合平面、曲面與各個角度的研磨。  
後方排氣可減少粉塵與噪音。



WX-127



WX-126



WX-125

Model 型號	Belt Size 砂布帶尺寸 mm	Belt Speed 砂布帶速度 m / min	Free Speed 無負載轉速 RPM	Length 長度 mm	Air Cons. 工作耗氣量 cfm (l/min)	Weight 重量 kg	Noise 噪音值 dB (A)	Packing 包裝明細 (CTN) PCS/N.W./G.W./CUFT
WX-125	10 x 330	1,301	18,000	280	9.3 (260)	0.81	85	20pcs/18kg/19kg/1.4'
WX-126	20 x 520	2,743	18,000	350	10.3 (290)	1.1	84	10pcs/13.2kg/14.2kg/1.4'
WX-127	30 x 540	2,042	13,000	390	10.3 (290)	2.1	85	6pcs/14kg/15kg/2.5'

• Air Inlet / 進氣口尺寸 : 1/4" PT or NPT

• Min. Hose Size / 進氣管尺寸 : 1/4" (6.35mm)

• Air Pressure / 空氣壓力 : 90 psi (6.2bar)

# Detailing Tools

## WS-111/WS-112 Series

With Regulator, easy to adjust speed  
Rear exhaust.

附流量調節器，可依使用需求調整適當的轉速  
後排氣設計。



### OPTION 選配件



purchase the proper type of screw converter to the specification of your pad

可選購合適的轉接螺絲以接母牙底盤

Screw Converter / 轉接螺絲

1. 311020110 -5/16-24UNF + M6
2. 311020100 -5/16-24UNF + 1/4-20 UNC



WS-111 / 111F / 111R



WS-112



WS-112R -Roloc Type

### WS-112R

Contents :

1. Mini Disc Sander x 1pc
2. Roloc Backing Pad x 1pc
3. Roloc Surface Conditioning Disc - Coarse #80 x1pc
4. Roloc Surface Conditioning Disc - Medium #150 x 1pc
5. Roloc Surface Conditioning Disc - Fine #300 x 1pc
6. Roloc Sanding Disc - #80 grit x 1pc

Model 型號	Pad Dia. 底盤尺寸	Orbit Dia 偏心直徑	Free Speed 無負載轉速	Length 長度	Height 高度	Weight 重量	Air Cons. 工作耗氣量	Noise 噪音值	Packing 包裝明細 (CTN)
	inch	mm	RPM	mm	mm	kg	cfm (l/min)	dB (A)	PCS/N.W./G.W./CUFT
WS-111	2" or 3"	1.5	18,000	176	95	0.65	7 (200)	88.7	10pcs/8.3kg/9.3kg/0.83'
WS-111F	2" or 3"	0.75	18,000	176	95	0.65	7 (200)	88.7	10pcs/8.3kg/9.3kg/0.83'
WS-111R	2" or 3"	3	18,000	176	95	0.65	7 (200)	88.7	10pcs/8.3kg/9.3kg/0.83'
WS-112	2" or 3"	N/A	18,000	176	99	0.59	7 (200)	88.5	10pcs/8kg/9kg/0.83'
WS-112R	2" or 3"	N/A	18,000	176	106	0.59	7 (200)	88.5	10pcs/9kg/10kg/0.9'



WX-114 / 114H / 114L



WX-118-2 / 118-3

Model 型號	Pad Dia. 底盤尺寸	Orbit Dia 偏心直徑	Free Speed 無負載轉速	Length 長度	Height 高度	Weight 重量	Air Cons. 工作耗氣量	Noise 噪音值	Packing 包裝明細 (CTN)
	inch or mm	mm	RPM	mm	mm	kg	cfm (l/min)	dB (A)	PCS/N.W./G.W./CUFT
WX-114	30 mm	1.5	7,500	162	75	0.62	7 (200)	74.9	20pcs/12.5kg/13.5kg/0.78'
WX-114H	30 mm	1.5	12,000	162	75	0.62	7 (200)	74.9	20pcs/12.5kg/13.5kg/0.78'
WX-114L	30 mm	1.5	5,500	162	75	0.62	7 (200)	74.9	20pcs/12.5kg/13.5kg/0.78'
WX-118-2	2"	3	15,000	168	75	0.7	1.87 (83)	87.9	20pcs/17.2kg/17.8kg/0.73'
WX-118-3	3"	3	15,000	168	75	0.7	1.87 (83)	87.9	20pcs/17.2kg/17.8kg/0.73'

# Finger Sander

## WS-113 Series



WS-113A / 113AF

311321300  
Hook Face / 黏扣面

311321200  
Rubber Face / 橡膠面

311321100  
Stainless Face / 不銹鋼面



WS-113B / 113BF

With Regulator, easy to adjust speed  
Rear exhaust.

附流量調節器，可依使用需求調整適當的轉速。  
後排氣設計。

Model 型號	Pad Dia. 底盤尺寸	Orbit Dia 偏心直徑	Free Speed 無負載轉速	Length 長度	Height 高度	Weight 重量	Air Cons. 工作耗氣量	Noise 噪音值	Packing 包裝明細 (CTN)
	mm	mm	RPM	mm	mm	kg	cfm (l/min)	dB (A)	PCS/N.W./G.W./CUFT
WS-113A	40 x 50	3	18,000	220	95	0.77	7 (200)	84.9	10pcs/8.7kg/9.7kg/0.9'
WS-113AF	40 x 50	1.5	18,000	220	95	0.77	7 (200)	84.9	10pcs/8.7kg/9.7kg/0.9'
WS-113B	17 x 65	3	18,000	220	95	0.77	7 (200)	84.9	10pcs/8.7kg/9.7kg/0.9'
WS-113BF	17 x 65	1.5	18,000	220	95	0.77	7 (200)	84.9	10pcs/8.7kg/9.7kg/0.9'

• Air Inlet / 進氣口尺寸 : 1/4" PT or NPT

• Min. Hose Size / 進氣管尺寸 : 1/4" (6.35mm)

• Air Pressure / 空氣壓力 : 90 psi (6.2bar)

## WS-106 Series

Alloy Steel gear is more durably after precise process and heat treatment.  
Suitable for the works of ultra meticulous sand rubbing, surface polishing, etc.

合金鋼齒輪組經精密加工並熱處理強化，耐用性超群。  
適用於超精細砂磨、錶面拋光等作業。



WS-106N-1V

WS-106N-3H

WS-106N-5H

### WS-106K

- Contents :
1. Mini Polisher x 1
  2. 3" Foam Polishing Pad/3"泡棉 x 1
  3. 3" Synthetic Wool Buffs/3" 羊毛輪 x1
  4. Wrench/板手 x 3 (14.19.22mm)
  5. 1-1/4" PAD/1-1/4" 底盤 x 1
  6. Adapter/偏心座組合 x1
  7. 3"PAD / 3" 底盤 x 1

Packing / 包裝明細 :  
12pcs / 16.2kg / 17.2kg / 2.6'



Model 型號	Pad Dia. 底盤尺寸	Pad Face 盤面規格	Orbit Dia 偏心直徑	Free Speed 無負載轉速	Weight 重量	Air Cons. 工作耗氣量	Noise 噪音值	Packing 包裝明細 (CTN)
WS-106N-1V	1-1/4"	Vinyl / Hook	5	2,400	0.83	6.7 (190)	77.5	12pcs/N.W./G.W./CUFT
WS-106N-3H	3"	Hook	N/A	2,400	0.74	6.7 (190)	77.5	12pcs/13.8kg/14.8kg/2.6'
WS-106N-5H	5"	Hook	N/A	2,400	0.8	6.7 (190)	77.5	12pcs/14.5kg/15.5kg/2.6'

• Air Inlet / 進氣口尺寸 : 1/4" PT or NPT

• Min. Hose Size / 進氣管尺寸 : 1/4" (6.35mm)

• Air Pressure / 空氣壓力 : 90 psi (6.2bar)

## WS-110 Series

With Regulator, easy to adjust speed,  
Rear exhaust

附流量調節器，可依使用需求調整適當的轉速  
後排氣設計。



WS-110 / 110H



WS-110R / 110HR  
Roloc Type

### OPTION 選配件



purchase the proper type of screw converter  
to the specification of your pad

可選購合適的轉接螺絲以便接母牙底盤

Screw Converter / 轉接螺絲

1. 311020110 -5/16-24UNF + M6
2. 311020100 -5/16-24UNF + 1/4-20 UNC

### WS-110R / WS-110HR

- Contents :
1. Mini Disc Sander x 1pc
  2. Roloc Backing Pad x 1pc
  3. Roloc Surface Conditioning Disc - Coarse #80 x1pc
  4. Roloc Surface Conditioning Disc - Medium #150 x 1pc
  5. Roloc Surface Conditioning Disc - Fine #300 x 1pc
  6. Roloc Sanding Disc - #80 grit x 1pc

Model 型號	Pad Dia. 底盤尺寸	Free Speed 無負載轉速	Length 長度	Height 高度	Weight 重量	Air Cons. 工作耗氣量	Noise 噪音值	Packing 包裝明細 (CTN)
WS-110	2" or 3"	3,000	187	121.5	0.8	7 (200)	90.8	10pcs/10kg/11kg/0.83'
WS-110R	2" or 3"	3,000	187	132	0.8	7 (200)	90.8	10pcs/11kg/12kg/0.9'
WS-110H	2" or 3"	4,500	187	121.5	0.8	7 (200)	90.8	10pcs/10kg/11kg/0.83'
WS-110HR	2" or 3"	4,500	187	132	0.8	7 (200)	90.8	10pcs/11kg/12kg/0.9'

• Air Inlet / 進氣口尺寸 : 1/4" PT or NPT

• Orbit Dia / 偏心直徑 : N/A

• Air Pressure / 空氣壓力 : 90 psi (6.2bar)

• Min. Hose Size / 進氣管尺寸 : 1/4" (6.35mm)

## WX-116 Series



WX-116 / 116H

Rear exhaust.

後排氣設計。

Model 型號	Pad Dia. 底盤尺寸	Free Speed 無負載轉速	Length 長度	Height 高度	Weight 重量	Air Cons. 工作耗氣量	Noise 噪音值	Packing 包裝明細 (CTN)
	inch	RPM	mm	mm	kg	cfm (l/min)	dB (A)	PCS/N.W./G.W./CUFT
WX-116	3"	2,300	248	54	1.1	2 (57)	88.5	20pcs/25kg/26kg/0.92'
WX-116H	3"	3,200	248	54	1.1	2 (57)	88.5	20pcs/25kg/26kg/0.92'

- Air Inlet / 進氣口尺寸 : 1/4" PT or NPT
- Orbit Dia / 偏心直徑 : N/A

- Air Pressure / 空氣壓力 : 90 psi (6.2bar)

- Min. Hose Size / 進氣管尺寸 : 1/4" (6.35mm)

## WX-1412 Series



WX-1412 / 1412S

Soft-grip handle can be positioned for right or left hand operation.

Variable speed safety-lock lever throttle adjust the speed during operation.

Insulated handle absorbs vibration and reduces cold air transmission to the operator.

軟式把手可調整左右使用方向。

可變速安全板機，操作時可調節速度。

絕緣材質握把可吸收震動力並降低冷空氣對使用者造成的影響。

Model 型號	Pad Dia. 底盤尺寸	Free Speed 無負載轉速	Length 長度	Height 高度	Weight 重量	Air Cons. 工作耗氣量	Noise 噪音值	Packing 包裝明細 (CTN)
	inch	RPM	mm	mm	kg	cfm (l/min)	dB (A)	PCS/N.W./G.W./CUFT
WX-1412	5"-8"	2,500	310	111	2.2	3 (85)	83	10pcs/25.1kg/26.1kg/2.3'
WX-1412S	5"-8"	4,500	310	111	2.2	3 (85)	83	10pcs/25.1kg/26.1kg/2.3'

- Air Inlet / 進氣口尺寸 : 1/4" PT or NPT
- Orbit Dia / 偏心直徑 : N/A

- Air Pressure / 空氣壓力 : 90 psi (6.2bar)

- Min. Hose Size / 進氣管尺寸 : 3/8" (9.5mm)

## WX-117 Series

### Economy 經濟型



WX-117 / 117P

Can be used with Sanding paper, Synthetic Wool Buffs and Sponge.

可搭配砂紙、羊毛輪、泡棉使用。

Model 型號	Pad Dia. 底盤尺寸	Free Speed 無負載轉速	Length 長度	Height 高度	Weight 重量	Air Cons. 工作耗氣量	Noise 噪音值	Packing 包裝明細 (CTN)
	inch	RPM	mm	mm	kg	cfm (l/min)	dB (A)	PCS/N.W./G.W./CUFT
WX-117	7"	4,500	320	99.5	2.25	6 (170)	85	6pcs/16kg/17kg/1.75'
WX-117P	7"	2,800	320	99.5	2.25	6 (170)	85	6pcs/16kg/17kg/1.75'

- Air Inlet / 進氣口尺寸 : 1/4" PT or NPT
- Spindle Thread Size / 螺牙尺寸 : 5/8 x 11UNF

- Min. Hose Size / 進氣管尺寸 : 1/4" (6.35mm)
- Air Pressure / 空氣壓力 : 90 psi (6.2bar)

- Orbit Dia / 偏心直徑 : N/A

# Abrasive Finishing Tool

## WX-173 Series

(Governor)



WX-173LW

W = Wheel / 輪子 LW = Long Arbor + Wheel / 長軸 + 輪子

Model 型號	Vac. Mode 集塵模式	Free Speed 無負載轉速 RPM	Length 長度 mm	Air Cons. 工作耗氣量 cfm (l/min)	Weight 重量 kg	Noise 噪音值 dB (A)	Packing 包裝明細 (CTN) PCS/N.W./G.W./CUFT
WX-173	Non. Vac.	3,400	344	4.2 (118)	1.84	85	10pcs/20kg/21kg/1.1'
WX-173W	Non. Vac.	3,400	394.5	4.2 (118)	2.68	85	5pcs/16.5kg/17kg/1.1'(含輪子)
WX-173LW	Non. Vac.	3,400	478	4.2 (118)	2.89	85	5pcs/16.5kg/17kg/1.1'(含輪子)

• Air Inlet / 進氣口尺寸 : 3/8" PT or NPT

• Min. Hose Size / 進氣管尺寸 : 3/8" (9.5mm)

• Air Pressure / 空氣壓力 : 90 psi (6.2bar)

## WX-172 Series

Needle bearing design for durable application

Working for stainless steel /aluminum /carbon steel /plastic /composite /fiberglass /wood and more.

Remove rust, oxide and scale; clean welds, remove paint and surface condition using abrasive flap wheels.

滾針軸承設計，堅固耐用的應用：

工作不銹鋼/鋁/碳鋼/塑料/複合/玻璃纖維/木等。

除去鐵鏽、氧化物和碎屑以及清潔焊渣，用研磨輪去除油漆和表面狀態。



WX-172ALG

WX-172CLG

NOT including Flap Wheels  
標準出貨不包含百葉輪

ALG = Adaptor Longer Grinder, CLG = Collet Longer Grinder

Model 型號	Collet Size 夾頭尺寸 inch (mm)	Free Speed 無負載轉速 RPM	Length 長度 mm	Air Cons. 工作耗氣量 cfm (l/min)	Weight 重量 kg	Noise 噪音值 dB (A)	Packing 包裝明細 (CTN) PCS/N.W./G.W./CUFT
WX-172ALG	N/A	4,500	309	3 (85)	1.1	88.8	10pcs/11kgs/11.5kgs/1.1'
WX-172CLG	1/4" (6mm)	4,500	285	3 (85)	1	87.3	10pcs/10kgs/10.5kgs/1.1'

• Air Inlet / 進氣口尺寸 : 1/4" PT or NPT

• Min. Hose Size / 進氣管尺寸 : 3/8" (9.5mm)

• Air Pressure / 空氣壓力 : 90 psi (6.2bar)



WX-174

NOT including Flap Wheels  
標準出貨不包含百葉輪

Model 型號	Wheel Size 輪子尺寸 mm	Free Speed 無負載轉速 RPM	Length 長度 mm	Air Cons. 工作耗氣量 cfm (l/min)	Weight 重量 kg	Noise 噪音值 dB (A)	Packing 包裝明細 (CTN) PCS/N.W./G.W./CUFT
WX-174	120 x 100	3,000	406	6 (170)	2.88	85	6pcs/19.8kgs/20.8kgs/1.75'

• Air Inlet / 進氣口尺寸 : 1/4" PT or NPT

• Min. Hose Size / 進氣管尺寸 : 3/8" (9.5mm)

• Air Pressure / 空氣壓力 : 90 psi (6.2bar)