

# Wrench Series 扳手工具

## AE 扳手

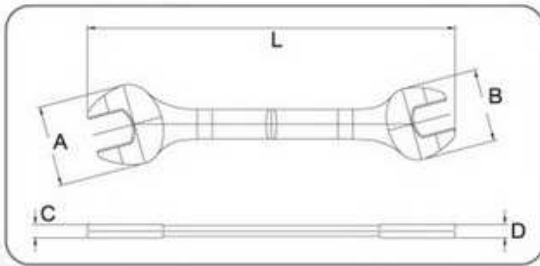

### CONFORMS TO DIN 3113 STANDARD

SIZE	L	A	B	C	D	G
6 x 7	123	15.5	17.5	3.7	3.7	21
6 x 8	123	15.5	17.5	3.7	3.7	21
8 x 9	140	20.1	22.6	4.2	4.3	36
8 x 10	140	20.1	22.5	4.2	4.3	36
10 x 11	156	24.8	27.0	5.2	5.5	57
10 x 12	156	24.8	27.0	5.2	5.5	57
11 x 13	172	29.0	31.0	5.4	5.6	73
12 x 13	172	29.0	31.0	5.4	5.6	73
12 x 14	180	30.0	32.0	5.6	5.7	77
14 x 15	190	33.3	33.6	5.8	6.0	93
14 x 17	190	33.3	33.6	5.8	6.0	93
16 x 17	204	36.9	38.5	6.3	6.4	128
17 x 19	221	40.8	42.7	6.5	6.7	162
18 x 19	221	40.8	42.7	6.5	6.7	162
19 x 22	237	44.6	48.6	6.9	7.1	200
20 x 22	237	44.6	48.6	6.9	7.1	200
21 x 23	247	46.7	50.9	7.6	8.1	257
22 x 24	247	46.7	50.9	7.6	8.1	257
23 x 26	259	51.6	57.3	8.2	8.8	303
24 x 26	259	51.6	57.3	8.2	8.8	303
24 x 27	259	51.6	57.3	8.2	8.8	303
25 x 28	279	54.6	61.0	8.5	9.0	336
30 x 32	298	65.4	69.8	8.9	9.2	463
32 x 36	347	68.9	74.9	10.7	10.7	595
36 x 41	380	74.9	86.0	12.7	13.2	926
41 x 46	400	86.0	94.8	15.0	15.0	1286
46 x 50	460	94.1	94.4	16.8	17.1	1895

## CE 扳手

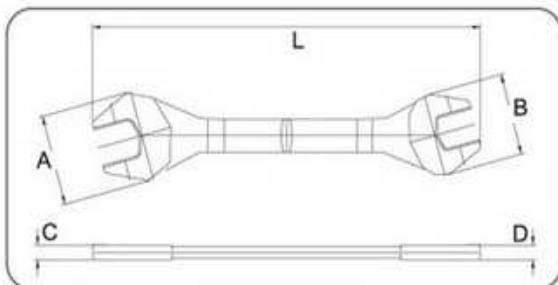

### CONFORMS TO DIN 3113 STANDARD

SIZE	L	A	B	C	D	G
6 x 7	115	18.3	22.0	4.5	4.6	36
8 x 9	115	18.3	22.0	4.5	4.6	36
8 x 10	115	18.3	22.0	4.5	4.6	36
10 x 11	130	23.1	27.1	5.9	6.0	50
10 x 12	130	23.1	27.1	5.9	6.0	50
11 x 13	142	26.9	30.0	6.1	6.3	77
12 x 13	142	26.9	30.0	6.1	6.3	77
12 x 14	142	26.9	30.0	6.1	6.3	77
14 x 15	162	30.0	35.0	6.5	6.5	87
14 x 17	165	30.2	35.2	6.8	6.6	90
16 x 17	165	30.2	35.2	6.8	6.6	90
17 x 19	180	37.7	40.3	6.9	7.0	133
18 x 19	180	37.7	40.3	6.9	7.0	133
19 x 21	205	38.9	43.5	7.4	7.1	170
20 x 22	205	38.9	43.5	7.4	7.1	170
21 x 23	215	45.8	49.3	8.2	8.5	245
22 x 24	215	45.8	49.3	8.2	8.5	245
23 x 26	230	48.7	52.0	8.7	8.8	395
24 x 27	230	48.7	52.0	8.7	8.8	395
25 x 28	260	52.1	57.8	9.1	9.7	502
30 x 32	285	63.4	68.5	11.4	11.5	607

# Wrench Series 扳手工具

## AE70°扳手

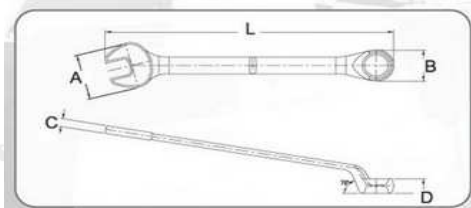
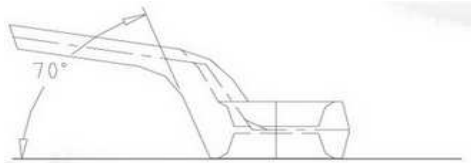

### CONFORMS TO DIN 3113 STANDARD

SIZE	L	A	B	C	D	G
6	102	15.2	10.3	3.9	5.1	16
7	112	17.3	11.5	4.1	6.3	20
8	122	19.2	13.1	4.3	6.6	25
9	131	21.1	14.0	4.8	7.3	33
10	140	23.1	15.7	4.8	8.2	41
11	150	25.0	17.0	5.3	8.4	50
12	160	26.4	18.7	5.4	9.0	58
13	170	29.2	21.1	5.5	9.5	74
14	180	31.4	21.6	5.8	9.7	88
15	190	33.1	22.9	6.2	9.7	103
16	200	34.8	24.3	6.0	10.5	116
17	210	36.3	25.2	6.5	11.5	135
18	220	38.7	27.3	6.7	13.0	155
19	230	40.4	28.3	7.2	13.4	184
21	260	46.6	30.8	7.8	14.8	247
22	260	46.6	30.8	7.8	14.8	247
24	280	50.4	34.4	8.3	15.2	311
27	310	55.3	38.4	8.5	16.2	390
30	340	61.0	41.7	9.2	18.2	500
32	360	65.5	44.5	10.1	19.5	621

## AR 2代平面扳手

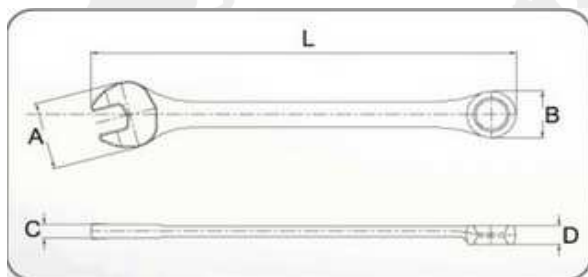

### CONFORMS TO AMERICAN NATIONAL STANDARD INSTITUTE (ANSI)

SIZE	L	A	B	C	D	G
6	98	14.3	9.6	3.9	4.6	16
7	98	14.3	9.6	3.9	4.6	16
8	102	17.9	11.4	4.2	4.9	20
9	116	21.9	14.8	5.0	6.4	36
10	123	23.1	16.8	5.5	7.0	39
11	131	24.0	17.4	5.5	7.7	44
12	138	25.5	19.0	5.7	8.1	53
13	148	27.0	20.2	5.9	8.7	62
14	168	30.6	21.7	6.2	8.9	83
15	189	32.3	23.9	6.6	9.7	107
16	189	32.6	23.9	6.6	9.7	107
17	207	36.6	26.6	7.0	10.1	135
18	230	38.8	28.4	7.7	10.6	165
19	230	38.8	28.4	7.7	10.6	165
20	260	42.7	31.2	9.4	11.7	219
21	260	42.7	31.2	9.4	11.7	219
22	284	44.3	33.4	8.8	12.3	256
23	284	44.3	33.4	8.8	12.3	256
24	310	49.1	36.1	9.5	12.5	350
25	333	51.0	37.7	10.7	13.4	395
26	333	51.0	37.7	10.7	13.4	395
27	361	53.9	38.9	12.6	15.9	422
28	361	53.9	38.9	12.6	15.9	422
29	382	57.3	43.2	13.1	16.3	624
30	382	57.3	43.2	13.1	16.3	624
32	412	62.6	44.7	13.9	17.7	698
1/4	98	14.3	9.6	3.9	4.6	16
5/16	102	17.9	11.4	4.2	4.9	20
11/32	116	21.9	14.8	5.0	6.4	36
3/8	116	21.9	14.8	5.0	6.4	36
7/16	131	24.0	17.4	5.5	7.7	44
1/2	148	27.0	20.2	5.9	8.7	62
9/16	168	30.6	21.7	6.2	8.9	83
5/8	189	32.6	23.9	6.6	9.7	107
11/16	207	36.6	26.6	7.0	10.1	135
3/4	230	38.8	28.4	7.7	10.6	165
13/16	260	42.7	31.2	9.4	11.7	219
7/8	284	44.3	33.4	8.8	12.3	256
15/16	310	49.1	36.1	9.5	12.5	350
1"	333	51.0	37.7	10.7	13.4	395
1-1/16	361	53.9	38.9	12.6	15.9	422
1-1/8	382	57.3	43.2	13.1	16.3	624
1-1/4	412	62.6	44.7	13.9	17.7	698

# Wrench Series 扳手工具

## AE75°扳手

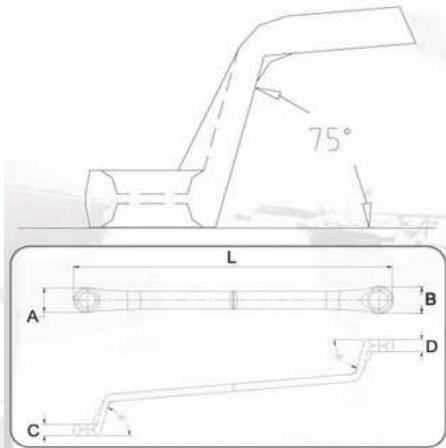

### CONFORMS TO DIN 838 STANDARD

SIZE	L	A	B	C	D	G
6 x 7	168	10.2	12.5	5.9	6.6	52
8 x 9	183	13.7	15.5	7.0	7.1	68
8 x 10	183	13.7	15.5	7.0	7.1	68
10 x 11	198	16.8	18.2	7.5	7.5	92
10 x 12	198	16.8	18.2	7.5	7.5	92
11 x 13	217	19.8	21.6	8.3	7.8	139
12 x 13	217	19.8	21.6	8.3	7.8	139
12 x 14	217	19.8	21.6	8.3	7.8	139
14 x 15	239	22.7	24.7	9.0	9.1	167
14 x 17	260	25.3	26.0	9.2	9.5	198
16 x 17	260	25.3	26.0	9.2	9.5	198
17 x 19	292	28.6	29.8	10.3	10.8	263
18 x 19	292	28.6	29.8	10.3	10.8	263
19 x 21	318	31.1	34.6	10.4	11.4	319
19 x 22	318	31.1	34.6	10.4	11.4	319
20 x 22	318	31.1	34.6	10.4	11.4	319
21 x 23	327	32.5	35.6	10.8	11.9	352
22 x 24	327	32.5	35.6	10.8	11.9	352
23 x 26	339	36.5	41.4	11.8	13.7	466
24 x 26	339	36.5	41.4	11.8	13.7	466
24 x 27	339	36.5	41.4	11.8	13.7	466
25 x 28	347	37.0	42.2	12.1	13.9	495
30 x 32	362	46.1	49.3	13.1	14.6	607

## PR45°扳手

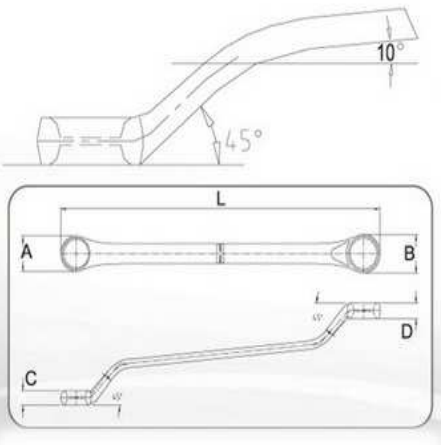

### CONFORMS TO DIN 897 STANDARD

SIZE	L	A	B	C	D	G
6 x 7	165	5.4	6.0	10.8	13.1	40
6 x 8	165	5.4	6.0	10.8	13.1	40
8 x 9	170	6.4	7.0	14.7	16.2	58
8 x 10	170	6.4	7.0	14.7	16.2	58
10 x 11	195	6.9	7.6	16.3	18.6	73
10 x 12	195	6.9	7.6	16.3	18.6	73
11 x 13	206	8.6	9.0	19.8	21.0	116
12 x 13	206	8.6	9.0	19.8	21.0	116
12 x 14	206	8.6	9.0	19.8	21.0	116
14 x 15	232	8.8	9.3	21.4	24.8	134
14 x 17	232	8.8	9.3	21.4	24.8	134
16 x 17	237	10.2	10.4	24.3	26.2	191
16 x 18	237	10.2	10.4	24.3	26.2	191
17 x 19	270	11.1	11.6	27.8	29.3	269
18 x 19	270	11.1	11.6	27.8	29.3	269
19 x 21	292	11.4	12.0	28.7	32.4	327
19 x 22	292	11.4	12.0	28.7	32.4	327
20 x 22	292	11.4	12.0	28.7	32.4	327
21 x 23	327	11.6	12.3	21.1	34.4	345
22 x 24	327	11.6	12.3	21.1	34.4	345
23 x 26	362	14.0	14.1	34.4	36.5	517
24 x 26	362	14.0	14.1	34.4	36.5	517
24 x 27	362	14.0	14.1	34.4	36.5	517
25 x 28	372	13.7	15.2	39.6	42.1	625
30 x 32	392	17.2	18.6	44.4	48.3	880
1/4 x 5/16	165	5.4	6.0	10.8	13.1	40
5/16 x 3/8	170	6.4	7.0	14.7	16.2	58
3/8 x 7/16	195	6.9	7.6	16.3	18.6	73
1/2 x 9/16	206	8.6	9.0	19.8	21.0	116
9/16 x 5/8	232	8.8	9.3	21.4	24.8	134
5/8 x 11/16	237	10.2	10.4	24.3	26.2	191
11/16 x 3/4	270	11.1	11.6	27.8	29.3	269
3/4 x 7/8	292	11.4	12.0	28.7	32.4	327
7/8 x 15/16	327	11.6	12.3	21.1	34.4	345
13/16 x 7/8	327	11.6	12.3	21.1	34.4	345
15/16 x 1"	362	14.0	14.1	34.4	36.5	517
1" x 1-1/8	372	13.7	15.2	39.6	42.1	625
1-1/8 x 1-1/4	392	17.2	18.6	44.4	48.3	880

## TR 扳手

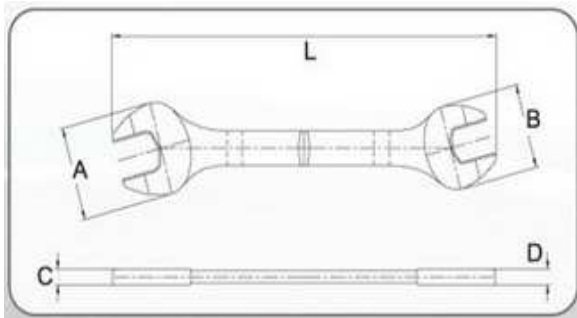

### CONFORMS TO DIN STANDARD

SIZE	L	A	B	C	D	G
6 x 7	108	14.3	16.1	4.5	4.6	27
8 x 9	127	17.1	19.1	5.0	5.5	32
10 x 11	141	20.5	23.3	5.7	5.9	58
12 x 13	163	27.0	29.7	6.5	6.8	93
14 x 15	185	29.2	32.8	7.2	7.4	122
16 x 18	208	33.5	38.6	7.4	7.5	170
17 x 19	225	36.2	39.2	8.2	8.4	212
19 x 22	240	37.6	43.0	8.6	9.1	235
20 x 22	240	37.6	43.0	8.6	9.1	235
21 x 23	252	42.6	45.1	8.8	8.9	277
23 x 26	293	49.5	51.6	9.8	9.9	410
24 x 26	293	49.5	51.6	9.8	9.9	410
24 x 27	293	49.5	51.6	9.8	9.9	410
30 x 32	340	55.9	66.4	12.1	12.3	693
1/4 x 5/16	108	14.3	16.1	4.5	4.6	27
3/8 x 7/16	141	20.5	23.3	5.7	5.9	58
1/2 x 9/16	163	27.0	29.7	6.5	6.8	93
9/16 x 5/8	185	29.2	32.8	7.2	7.4	122
5/8 x 11/16	208	33.5	38.6	7.4	7.5	170
11/16 x 3/4	225	36.2	39.2	8.2	8.4	212
3/4 x 7/8	240	37.6	43.0	8.6	9.1	235
15/16 x 1"	293	49.5	51.6	9.8	9.9	410
1-1/8x1-1/4	340	55.9	66.4	12.1	12.3	693

## 美式雙開口扳手

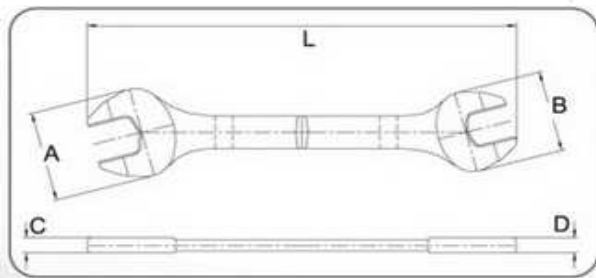

### CONFORMS TO AMERICAN NATIONAL STANDARD INSTITUTE (ANSI)

SIZE	L	A	B	C	D	G
6 x 7	97	16.2	17.3	4.0	4.3	26
8 x 9	110	18.2	19.7	4.6	4.7	32
8 x 10	110	18.2	19.7	4.6	4.7	32
10 x 11	126	22.2	25.9	5.5	5.6	54
10 x 12	128	23.0	26.0	5.7	5.8	55
11 x 13	142	26.7	28.4	6.1	6.2	74
12 x 13	142	26.7	28.4	6.1	6.2	74
14 x 15	156	28.2	31.3	6.4	6.5	87
16 x 17	172	33.0	35.8	6.7	6.5	118
18 x 19	188	37.0	38.8	7.2	7.3	158
19 x 21	210	41.1	45.8	8.4	8.6	258
20 x 22	210	41.1	45.8	8.4	8.6	258
21 x 23	210	41.1	45.8	8.4	8.6	258
22 x 24	210	41.1	45.8	8.4	8.6	258
23 x 26	255	48.0	50.8	8.6	8.8	322
24 x 27	255	48.0	50.8	8.6	8.8	322
25 x 28	265	58.0	64.0	12.0	12.1	615
30 x 32	295	60.0	66.0	12.2	12.4	620
1/4 x 5/16	97	16.2	17.3	4.0	4.3	26
3/8 x 7/16	126	22.2	25.9	5.5	5.6	54
7/16 x 1/2	141	26.7	28.4	6.2	6.0	74
1/2 x 9/16	156	28.2	31.3	6.4	6.5	87
5/8 x 11/16	172	33.0	35.8	6.7	6.5	118
11/16 x 3/4	188	37.0	38.8	7.2	7.3	158
13/16 x 7/8	210	41.1	45.8	8.4	8.6	258
7/8 x 15/16	210	41.1	45.8	8.4	8.6	258
15/16 x 1"	255	48.0	50.8	8.6	8.8	322
1" 1/8 x 1/4	295					

# Wrench Series 扳手工具

## CE45°扳手

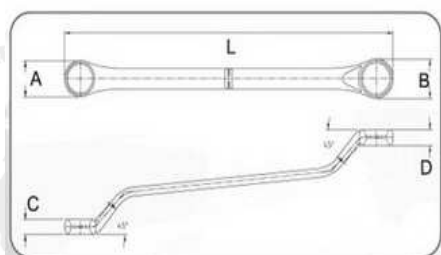
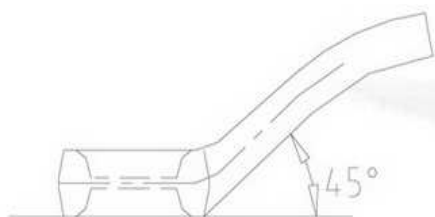

### CONFORMS TO DIN 897 STANDARD

SIZE	L	A	B	C	D	G
6 x 7	161	14.5	16.2	5.8	7.0	50
8 x 9	170	15.2	17.0	6.2	7.3	58
8 x 10	170	15.2	17.0	6.2	7.3	58
8 x 11	170	15.2	17.0	6.2	7.3	58
10 x 11	192	16.0	18.6	7.0	8.5	77
10 x 12	192	16.0	18.6	7.0	8.5	77
11 x 13	223	16.2	18.9	7.2	8.7	115
12 x 13	223	16.2	18.9	7.2	8.7	115
12 x 14	223	16.2	18.9	7.2	8.7	115
14 x 15	250	16.4	19.3	7.4	8.9	150
14 x 17	250	16.4	19.3	7.4	8.9	150
16 x 17	250	16.4	19.3	7.4	8.9	150
17 x 19	284	19.0	22.2	8.8	9.1	167
18 x 19	284	19.0	22.2	8.8	9.1	167
19 x 21	300	27.0	29.4	10.3	11.7	224
20 x 22	320	30.3	32.8	11.4	11.9	237
21 x 23	340	33.6	36.2	13.8	14.3	329
22 x 24	340	33.6	36.2	13.8	14.3	329
23 x 26	380	36.3	40.5	12.3	14.3	455
24 x 26	365	36.3	40.5	12.3	14.3	455
25 x 28	370	39.7	45.7	15.0	16.4	527
26 x 29	395	39.7	45.7	15.0	16.4	527
27 x 30	395	39.7	45.7	15.0	16.4	527
26 x 32	395	42.8	47.7	15.2	16.6	642
29 x 32	395	42.8	47.7	15.2	16.6	642
30 x 32	395	42.8	47.7	15.2	16.6	642
32 x 36	440	46.4	48.2	15.4	16.8	699
32 x 38	440	46.4	48.2	15.4	16.8	699

## E75°扳手

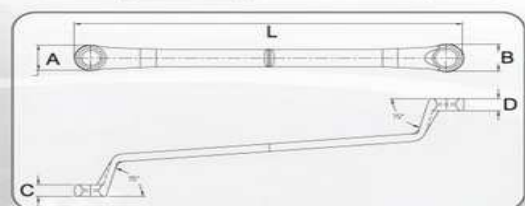

### CONFORMS TO DIN 897 STANDARD

SIZE	L	A	B	C	D	G
6 x 8	147	10.0	12.3	5.5	6.2	32
7 x 11	159	11.3	14.5	5.6	7.0	43
10 x 12	175	13.5	15.5	5.9	6.8	50
14 x 18	215	17.3	21.7	7.7	9.3	108
16 x 22	234	20.1	27.4	8.1	11.6	157
20 x 24	262	23.5	28.2	11.3	13.3	223

# Wrench Series 扳手工具

## CWAD45° 扳手

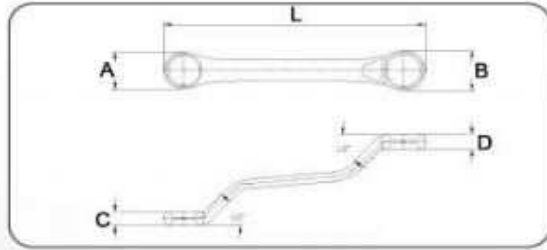

### CAR REPAIR

SIZE	L	A	B	C	D	G
10 x 11	115	15.3	17.8	6.9	7.0	48
10 x 12	115	15.3	17.8	6.9	7.0	48
10 x 13	115	15.9	20.5	7.7	8.0	55
12 x 13	140	20.0	22.0	8.9	9.1	70
12 x 14	140	20.0	22.0	8.9	9.1	70
14 x 15	148	24.5	25.9	10.0	10.4	100
14 x 17	148	24.5	25.9	10.0	10.4	100
16 x 18	148	24.5	25.9	10.0	10.4	100
17 x 19	155	25.0	28.6	10.8	11.3	123
3/8 x 7/16	122	15.3	17.8	6.9	7.0	48
1/2 x 9/16	147	20.0	22.0	8.9	9.1	70
5/8 x 11/16	162	24.5	25.9	10.0	10.4	100
5/8 x 3/4	175	25.0	28.6	10.8	11.3	123

## CWAS 扳手

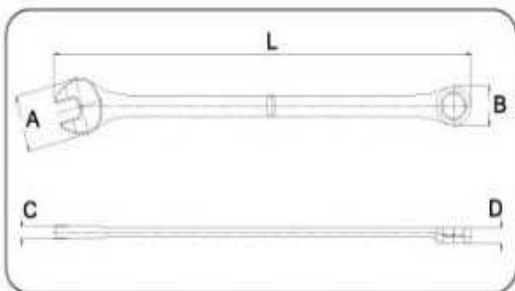

### CAR REPAIR

SIZE	L	A	B	C	D	G
6	128	13.1	9.5	3.7	4.9	24
7	138	13.1	9.5	3.7	4.9	24
8	148	16.5	11.0	4.6	5.2	30
9	160	18.0	12.3	4.9	6.0	35
10	167	21.6	14.6	5.1	6.4	45
11	186	23.7	16.2	5.8	6.8	60
12	196	25.7	18.5	6.2	7.6	71
13	205	27.2	20.2	6.8	8.9	95
14	223	30.3	21.5	7.4	9.3	119
15	233	33.5	23.8	8.5	10.7	155
16	233	33.5	23.8	8.5	10.7	155
17	262	34.7	25.6	8.7	11.7	195
18	271	38.4	28.1	8.6	12.0	237
19	281	38.8	27.4	8.7	12.4	215
20	301	43.2	30.8	9.5	13.2	295
21	301	43.2	30.8	9.5	13.2	295
22	319	45.5	32.3	9.6	13.9	300
23	339	47.8	33.8	9.8	14.7	375
24	339	47.8	33.8	9.8	14.7	375
25	358	52.2	37.0	11.2	15.9	491
26	358	52.2	37.0	11.2	15.9	491
27	388	56.1	39.4	11.7	18.4	625
28	388	56.1	39.4	11.7	18.4	625
29	404	60.4	42.2	12.5	18.5	721
30	404	60.4	42.2	12.5	18.5	721
32	430	64.6	45.7	13.5	20.1	840
1/4	128	13.1	9.5	3.7	4.9	24
5/16	148	16.5	11.0	4.6	5.2	30
3/8	167	21.6	14.6	5.1	6.4	45
7/16	186	23.7	16.2	5.8	6.8	60
1/2	205	27.2	20.2	6.8	8.9	95
9/16	223	30.3	21.5	7.4	9.3	119
5/8	233	33.5	23.8	8.5	10.7	155
11/16	262	34.7	25.6	8.7	11.7	195
3/4	281	38.8	27.4	8.7	12.4	215
13/16	301	43.2	30.8	9.5	13.2	295
7/8	319	45.5	32.3	9.6	13.9	300
15/16	339	47.8	33.8	9.8	14.7	375
1"	358	52.2	37.0	11.2	15.9	491
1-1/16	388	56.1	39.4	11.7	18.4	625
1-1/8	404	60.4	42.2	12.5	18.5	721
1-1/4	430	64.6	45.7	13.5	20.1	840

# Wrench Series 扳手工具

## CWE 扳手

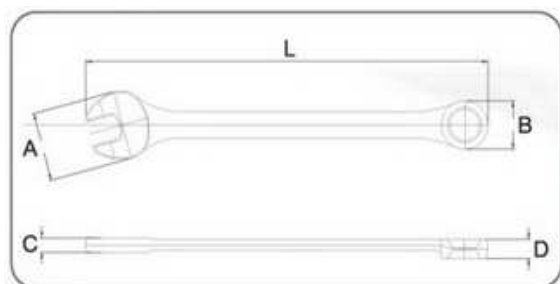

### CONFORMS TO DIN 3113 STANDARD

SIZE	L	A	B	C	D	G
6	102	15.7	10.4	3.6	4.5	17
7	112	17.2	11.6	4.0	4.9	20
8	122	19.6	12.8	4.5	5.3	26
9	132	21.5	14.6	4.7	5.7	35
10	140	23.8	16.2	4.9	6.6	40
11	150	25.6	17.5	5.0	6.9	50
12	160	27.4	18.4	5.4	7.2	59
13	170	29.6	19.8	5.9	7.7	75
14	180	31.7	21.6	6.2	8.6	92
15	190	33.2	23.1	6.5	8.7	95
16	200	34.7	24.5	6.6	8.9	109
17	210	36.8	25.8	6.7	8.9	122
18	220	38.8	26.9	7.1	9.9	149
19	230	40.8	28.6	7.4	10.3	165
20	240	43.0	29.7	7.6	10.5	185
21	250	45.3	31.8	7.8	11.0	209
22	260	46.6	32.7	8.0	11.7	231
23	270	47.7	33.5	8.4	11.9	234
24	280	50.4	35.9	8.5	12.2	274
25	290	52.5	36.9	8.8	12.3	286
26	300	53.0	38.2	9.0	12.4	310
27	310	53.3	38.5	9.2	12.5	330
28	320	56.6	40.5	9.3	12.6	388
29	330	59.0	41.4	9.5	12.8	419
30	340	62.3	43.9	9.9	13.2	474
32	360	65.7	45.7	10.3	14.0	523
33	380	69.2	50.2	11.6	15.7	686
34	380	69.2	50.2	11.6	15.7	686
35	410	74.6	54.3	13.2	18.5	878
36	410	74.6	54.3	13.2	18.5	878
38	440	77.0	57.0	14.4	19.0	968
41	460	83.6	61.3	14.5	21.5	1234
42	460	83.6	61.3	14.5	21.5	1234
43	460	83.6	61.3	14.5	21.5	1234
44	500	89.3	63.9	15.0	21.7	1566
45	500	89.3	63.9	15.0	21.7	1566
46	500	89.3	63.9	15.0	21.7	1566
48	540	97.0	73.5	16.9	23.1	1951
50	540	97.0	73.5	16.9	23.1	1951

## CWAD 扳手

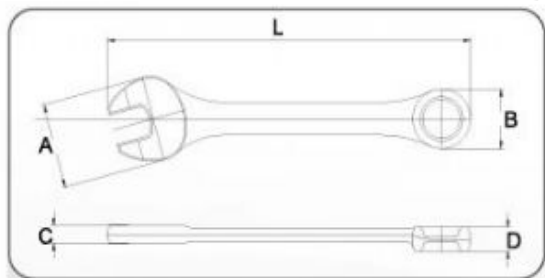

### CAR REPAIR

SIZE	L	A	B	C	D	G
6	77	13.1	10.0	4.6	5.8	14
7	80	15.8	10.3	5.0	5.8	17
8	85	17.8	13.5	5.2	5.9	22
9	90	18.9	14.2	5.2	6.0	29
10	95	22.2	16.1	5.8	7.5	37
11	100	23.9	17.9	6.1	7.8	45
12	104	25.5	19.1	6.6	7.8	51
13	109	27.1	19.9	7.0	9.1	54
14	114	29.2	21.8	7.6	9.4	71
15	120	30.1	22.5	7.8	9.6	76
16	124	32.8	24.1	7.9	9.8	88
17	130	35.8	26.1	8.7	10.8	115
18	134	36.7	27.0	9.1	11.0	118
19	140	38.1	28.6	9.9	11.9	148
22	165	39.7	29.8	10.3	12.5	220
1/4	77	13.1	10.0	4.6	5.8	14
5/16	85	17.8	13.5	5.2	5.9	22
3/8	95	22.2	16.1	5.8	7.5	37
7/16	100	23.9	17.9	6.1	7.8	45
1/2	109	27.1	19.9	7.0	9.1	54
9/16	114	29.2	21.8	7.6	9.4	71
5/8	124	32.8	24.1	7.9	9.8	88
11/16	130	35.8	26.1	8.7	10.8	115
3/4	140	38.1	28.6	9.9	11.9	148

# Wrench Series 扳手工具

## Ė扳手

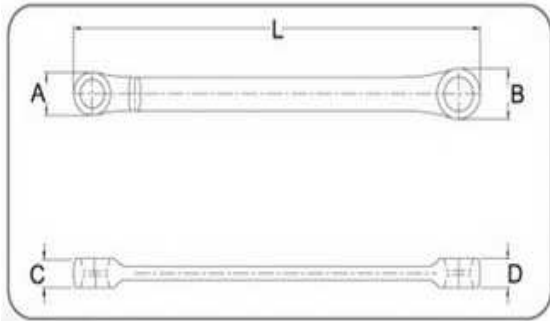

### CONFORMS TO DIN 897 STANDARD

SIZE	L	A	B	C	D	G
6 x 8	114	7.3	9.7	4.2	5.3	17
7 x 11	130	10.8	14.8	5.2	7.2	31
10 x 12	141	12.3	15.1	6.5	7.7	36
14 x 18	180	17.0	21.1	8.2	10.3	88
16 x 22	205	19.7	27.3	8.4	11.8	130
20 x 24	224	23.9	27.9	11.0	12.6	165

## 美式45°扳手

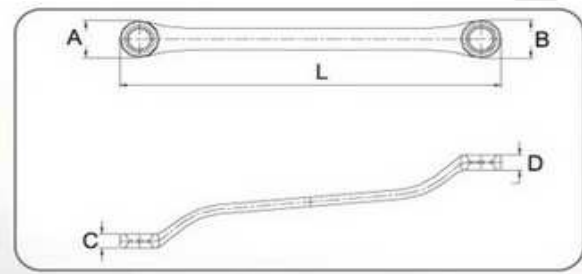

### CONFORMS TO AMERICAN NATIONAL STANDARD INSTITUTE (ANSI)

SIZE	L	A	B	C	D	G
6 x 7	185	13.8	15.0	6.2	6.5	51
8 x 9	185	13.8	15.0	6.2	6.5	51
8 x 10	185	13.8	15.0	6.2	6.5	51
10 x 11	195	16.0	18.4	6.5	6.8	54
10 x 12	195	16.0	18.4	6.5	6.8	54
11 x 13	210	19.3	21.8	7.3	7.7	87
12 x 13	210	19.3	21.8	7.3	7.7	87
12 x 14	210	19.3	21.8	7.3	7.7	87
14 x 15	240	24.0	26.9	8.7	9.3	164
14 x 17	240	24.0	26.9	8.7	9.3	164
16 x 17	240	24.0	26.9	8.7	9.3	164
17 x 19	280	28.8	32.7	10.6	10.5	263
18 x 19	280	28.8	32.7	10.6	10.5	263
19 x 21	280	28.8	32.7	10.6	10.5	263
21 x 23	317	31.3	33.8	10.7	10.8	315
22 x 24	317	31.3	33.8	10.7	10.8	315
23 x 26	365	35.4	38.2	11.8	12.2	480
24 x 27	365	35.4	38.2	11.8	12.2	480
25 x 28	370	39.6	46.8	14.1	16.1	636
30 x 32	375	46.6	48.2	15.0	16.4	780
5/16 x 3/8	195	16.0	1.4	6.5	6.8	54
1/2 x 9/16	210	19.3	21.8	7.3	7.7	87
5/8 x 11/16	240	24.0	26.9	8.7	9.3	164
11/16 x 3/4	280	28.8	32.7	10.6	10.5	263
3/4 x 13/16	280	28.8	32.7	10.6	10.5	263
3/4 x 7/8	280	28.8	32.7	10.6	10.5	263
7/8 x 15/16	317	31.3	33.8	10.7	10.8	315
15/16 x 1"	365	35.4	38.2	11.8	12.2	480
1" x 1-1/16	370	39.6	46.8	14.1	16.1	636
1-1/8 x 1-1/4	375	46.6	48.2	15.0	16.4	780



## TR45° 扳手

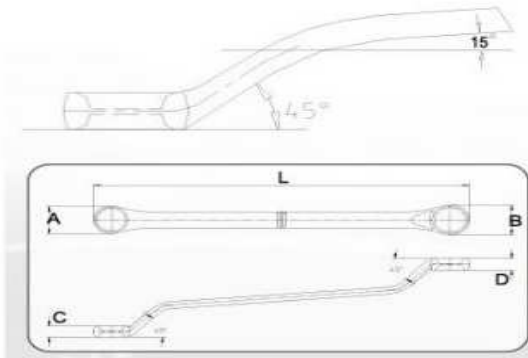

### CONFORMS TO ANSI STANDARD

SIZE	L	A	B	C	D	G
6 x 7	161	10.0	11.9	5.5	5.7	36
6 x 8	161	10.0	11.9	5.5	5.7	36
8 x 9	178	13.2	14.2	6.5	6.2	46
8 x 10	178	13.2	14.2	6.5	6.2	46
10 x 11	195	15.5	18.0	6.6	7.0	59
10 x 12	195	15.5	18.0	6.6	7.0	59
11 x 13	214	17.7	20.4	8.0	8.2	89
12 x 13	214	17.7	20.4	8.0	8.2	89
12 x 14	230	20.4	23.3	8.9	9.2	118
14 x 15	246	22.7	24.3	10.3	10.0	153
14 x 17	260	24.8	25.8	10.6	11.2	161
16 x 17	260	24.8	25.8	10.6	11.2	161
17 x 19	295	26.3	29.2	11.1	11.7	245
18 x 19	310	26.3	19.2	11.1	11.7	245
19 x 21	320	28.6	32.8	11.5	12.1	282
20 x 22	320	30.9	33.7	12.2	13.4	350
22 x 24	350	36.3	37.5	13.8	14.2	478
23 x 26	350	36.3	37.5	13.8	14.2	478
24 x 26	350	36.3	37.5	13.8	14.2	478
24 x 27	350	36.3	37.5	13.8	14.2	478
1/4 x 5/16	161	10.0	11.9	5.5	5.7	36
3/8 x 7/16	195	15.5	18.0	6.6	7.0	59
1/2 x 9/16	230	20.4	23.3	8.9	9.2	118
9/16 x 5/8	246	22.7	24.3	10.3	10.0	153
5/8 x 11/16	255	24.8	25.8	10.6	11.2	161
5/8 x 3/4	295	26.3	19.2	11.1	11.7	245
11/16 x 3/4	295	26.3	29.2	11.1	11.7	245
3/4 x 7/8	310	28.6	32.8	11.5	12.1	282
13/16 x 7/8	320	30.9	33.7	12.2	13.4	350

## 直柄雙梅短扳手

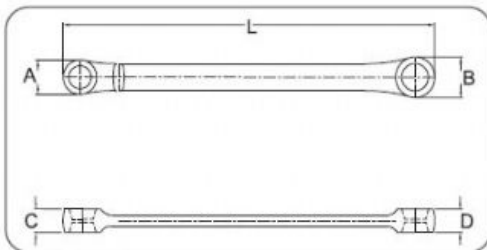

### CAR REPAIR

SIZE	L	A	B	C	D	G
8x10	180	13.0	15.5	5.0	6.0	40
10x11	205	15.5	18.0	6.0	7.0	70
10x12	205	15.5	18.0	6.0	7.0	70
12x13	224	18.0	21.0	7.0	8.0	100
12x14	224	18.0	21.0	7.0	8.0	100
14x15	245	21.0	25.0	8.0	8.5	140
14x17	245	21.0	25.0	8.0	8.5	140
16x18	284	25.0	27.5	8.5	9.0	210
17x19	284	25.0	27.5	8.5	9.0	210

# Wrench Series 扳手工具

## TRQ快速扳手

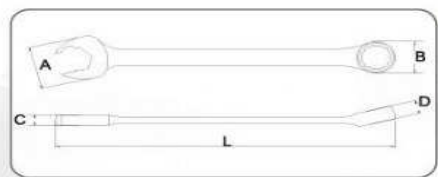
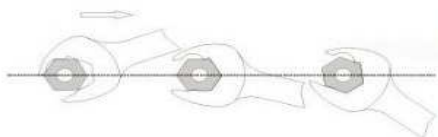

CONFORMS TO AMERICAN NATIONAL STANDARD INSTITUTE (ANSI)

SIZE	L	A	B	C	D	G
8	148	18.9	12.6	4.7	5.7	32
9	154	20.6	15.6	5.8	8.1	46
10	162	21.5	14.4	6.0	8.3	48
11	165	23.0	17.8	6.8	8.5	62
12	174	25.6	18.3	6.9	7.9	70
13	178	26.3	20.3	7.1	8.8	71
14	190	28.9	22.1	7.7	9.6	95
15	205	32.6	24.5	8.5	10.7	124
16	205	32.6	24.5	8.5	10.7	124
17	225	36.3	26.7	8.8	11.0	155
18	248	38.6	28.3	9.2	11.2	176
19	248	38.6	28.3	9.2	11.2	176
5/16	148	18.9	12.6	4.7	5.7	32
3/8	154	21.5	14.4	6.0	8.3	48
7/16	165	23.0	17.8	6.8	8.5	62
1/2	178	26.3	20.3	7.1	8.8	71
9/16	190	28.9	22.1	7.7	9.6	95
5/8	205	32.6	24.5	8.5	10.7	124
11/16	225	36.3	26.7	8.8	11.0	155
3/4	248	38.6	28.3	9.2	11.2	176

## 美式二代扳手

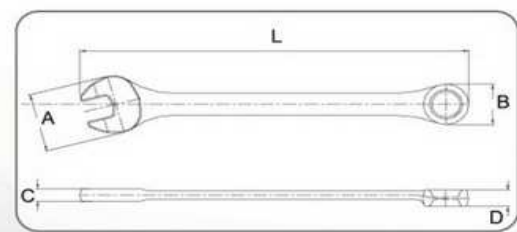

CONFORMS TO AMERICAN NATIONAL STANDARD INSTITUTE (ANSI)

SIZE	L	A	B	C	D	G
6	90	15.7	10.4	4.4	5.0	22
7	98	17.1	12.1	4.5	5.3	24
8	102	19.2	12.8	4.6	5.5	27
9	116	21.2	14.8	5.1	6.2	35
10	123	23.2	16.6	5.1	6.3	52
11	131	24.5	17.3	5.6	6.7	52
12	142	25.4	18.4	5.6	7.1	62
13	148	27.9	20.0	5.7	7.6	67
14	168	30.1	21.7	6.7	8.2	88
15	189	31.7	24.1	7.1	9.1	110
16	189	31.7	24.1	7.1	9.1	110
17	207	36.5	26.7	7.8	9.8	155
18	207	36.5	26.7	7.8	9.8	155
19	230	39.8	29.3	7.8	10.4	185
20	260	43.3	31.5	9.4	11.9	271
21	260	43.3	31.5	9.4	11.9	271
22	280	44.4	33.6	9.6	12.2	286
23	280	44.4	33.6	9.6	12.2	286
24	310	49.0	35.8	10.6	12.4	421
25	333	51.4	37.9	11.0	12.7	476
26	333	51.4	37.9	11.0	12.7	476
27	361	57.1	42.0	11.1	13.1	584
28	361	57.1	42.0	11.1	13.1	584
29	382	59.5	43.7	11.8	13.7	620
30	382	59.5	43.7	11.8	13.7	620
32	412	63.8	48.3	12.1	14.8	781
33	435	66.7	49.3	14.3	18.2	994
34	435	66.7	49.3	14.3	18.2	994
35	455	68	50.4	15.1	19.5	1180
36	490	73.5	54	16.3	20.5	1377
38	490	73.5	54	16.3	20.5	1377
41	545	92	65	16.3	21.8	1880
42	545	92	65	16.3	21.8	1880
43	545	92	65	16.3	21.8	1880
44	545	92	65	16.3	21.8	1880
46	545	92	65	16.3	21.8	1880
48	610	96.8	73	18	22	2583
50	610	96.8	73	18	22	2583
55	630	113	92	21	30	3930
58	630	113	92	21	30	3930
60	630	113	92	21	30	3930

# Wrench Series 扳手工具

## TR 扳手

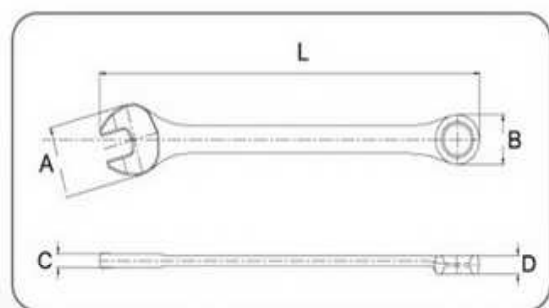

CONFORMS TO AMERICAN NATIONAL  
STANDARD INSTITUTE (ANSI)

SIZE	L	A	B	C	D	G
6	128	13.7	10.5	4.3	4.6	21
7	138	15.2	11.6	4.6	5.1	25
8	148	18.9	12.6	4.7	5.7	32
9	154	20.6	15.6	5.8	8.1	46
10	162	21.5	14.4	6.0	8.3	48
11	167	23.0	17.8	6.8	8.5	62
12	174	25.6	18.3	6.9	7.9	70
13	178	26.3	20.3	7.1	8.8	71
14	190	28.9	22.1	7.7	9.6	95
15	205	32.6	24.5	8.5	10.7	124
16	205	32.6	24.5	8.5	10.7	124
17	225	36.3	26.7	8.8	11.0	155
18	248	38.6	28.3	9.2	11.2	176
19	248	38.6	28.3	9.2	11.2	176
20	270	42.5	30.5	9.8	12.4	233
21	270	42.5	30.5	9.8	12.4	233
22	292	46.5	33.3	10.4	12.9	287
23	314	48.5	35.4	10.8	13.9	332
24	314	48.5	35.4	10.8	13.9	332
25	336	50.4	36.5	11.4	14.4	422
26	336	50.4	36.5	11.4	14.4	422
27	359	53.5	38.4	12.3	15.4	512
28	390	57.2	43.1	12.9	15.8	664
29	390	57.2	43.1	12.9	15.8	664
30	390	57.2	43.1	12.9	15.8	664
32	425	62.0	45.1	13.0	16.4	847
1/4	128	13.7	10.5	4.3	4.6	21
5/16	148	18.9	12.6	4.7	5.7	32
3/8	154	20.6	15.6	5.8	8.1	46
7/16	167	23.0	17.8	6.8	8.5	62
1/2	178	26.3	20.3	7.1	8.8	71
9/16	190	28.9	22.1	7.7	9.6	95
5/8	205	32.6	24.5	8.5	10.7	124
11/16	225	36.3	26.7	8.8	11.0	155
3/4	248	38.6	28.3	9.2	11.2	176
13/16	270	42.5	30.5	9.8	12.4	233
7/8	292	46.5	33.3	10.4	12.9	287
15/16	314	48.5	35.4	10.8	13.9	332
1"	336	50.4	36.5	11.4	14.4	422
1-1/16	359	53.5	38.4	12.3	15.4	512
1-1/8	390	57.2	43.1	12.9	15.8	664
1-1/4	425	62.0	45.1	13.0	16.4	847

# Wrench Series 扳手工具

## 加長型棘輪單向扳手

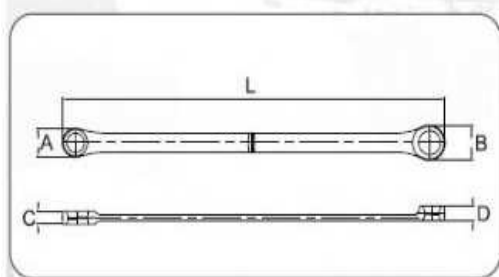
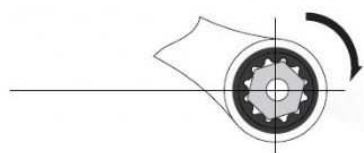

## CAR REPAIR

SIZE	L	A	B	C	D	G
8	235	15.9	12.3	6.7	7.3	80
10	292	20.2	14.5	8.0	7.8	124
12	328	23.3	17.3	8.6	10.3	170
13	348	22.9	18.7	8.9	10.6	194
14	368	27.5	20.8	9.3	10.9	230
15	386	26.4	21.1	9.7	12.4	248
17	408	31.8	24.0	10.8	12.4	292
19	420	34.5	26.3	12.3	14.1	410

## 單向棘輪GW扳手

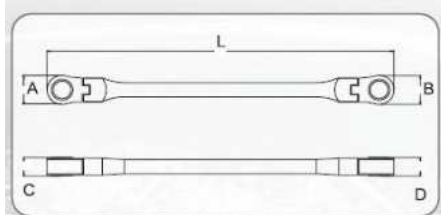
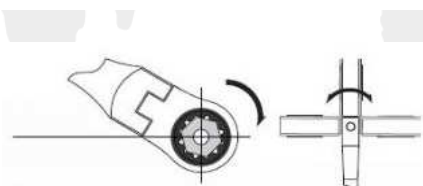

## CAR REPAIR

SIZE	L	A	B	C	D	G
8x10	236.6	15.4	18.8	7.4	8.8	221.6
10x11	294.0	18.8	21.3	8.8	9.2	317.2
10x12	294.0	18.8	21.3	8.8	9.2	317.2
11x13	329.7	21.3	26.8	9.2	10.1	401.7
12x14	329.7	21.3	26.8	9.2	10.1	401.7
13x15	369.9	26.8	28.4	10.1	11.6	638.8
14x17	369.9	26.8	28.4	10.1	11.6	638.8
16x18	411.6	28.4	31.0	11.6	13.0	640.4
17x19	411.6	28.4	31.0	11.6	13.0	640.4

# Wrench Series 扳手工具

## 打擊梅花扳手

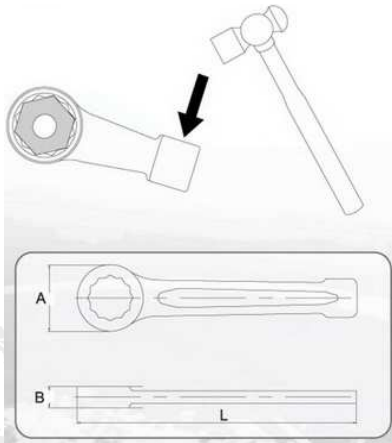

### CONFORMS TO DIN 7444 STANDARD

SIZE	L	A	B
24	168	43.4	14.8
27	180	46	16
30	190	51.5	17
32	190	54	17
36	205	58.5	18.5
38	228	64.6	20.1
41	230	65	20
46	240	73.5	22
50	253	78.5	24
55	266	85	25
60	280	92	26
65	300	102	30
70	330	110	33
75	330	110	33
80	340	118	34
85	355	130	36
90	390	142	39
95	390	142	39
100	420	155	43
105	420	155	43
110	450	168	45
115	450	168	45
120	480	182	50
125	480	182	50
130	510	194	57
135	510	194	57
140	520	205	58
145	565	215	58
150	565	215	58

## 鴉爪

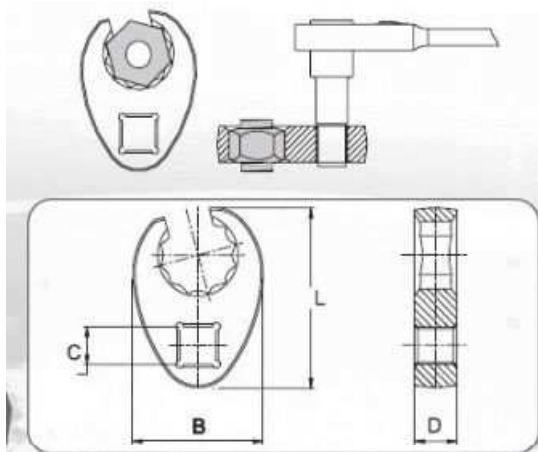

### CONFORMS TO AMERICAN NATIONAL STANDARD INSTITUTE

SIZE	L	B	D	C	G
10 (3/8)	36.5	27.7	9.0	3/8"	40
11 (7/16)	36.5	27.7	9.0	3/8"	37
12	36.5	27.7	9.0	3/8"	36
13 (1/2)	36.5	27.7	9.0	3/8"	35
14 (9/16)	41.5	30.3	10.0	3/8"	50
15 (5/8)	41.5	30.3	10.0	3/8"	50
16	41.5	30.3	10.0	3/8"	45
17 (11/16)	45.7	34.2	11.0	3/8"	64
18	45.7	34.2	11.0	3/8"	62
19 (3/4)	45.7	34.2	11.0	3/8"	60
20	53	36.4	12.8	1/2"	77
21	53	36.4	12.8	1/2"	79
22	55.6	38.6	13.2	1/2"	85
23	55.6	38.6	13.2	1/2"	111
24	55.6	38.6	13.2	1/2"	107
25	61	42.5	14	1/2"	107
26	61	42.5	14	1/2"	113
27	61	42.5	14	1/2"	115
28	69.5	49.6	14.5	1/2"	154
29	69.5	49.6	14.5	1/2"	151
30	69.5	49.6	14.5	1/2"	148
32	70	50	14.5	1/2"	142
33	84	55.4	22	3/4"	335
34	84	55.4	22	3/4"	332
35	84	55.4	22	3/4"	324
36	84	55.4	22	3/4"	313
38	91	61.5	23.8	3/4"	493
41	91	61.5	23.8	3/4"	377
46	102	70	25.1	3/4"	519
48	102	70	25.1	3/4"	493

**ABERLA®**

# Wrench Series 扳手工具

## 單搖頭棘輪單向扳手

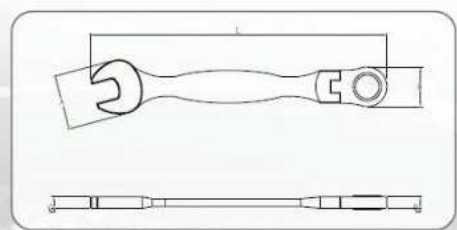
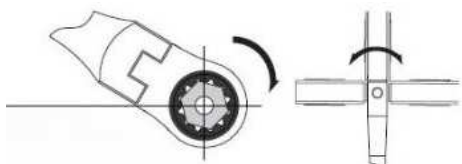

## CAR REPAIR

SIZE	L	A	B	C	D	G
8	140	16,7	4,3	4,3	6,6	38,8
9	148	18,0	4,7	4,7	7,3	48,1
10	160	19,6	4,9	4,9	7,9	55,6
11	165	21,1	5,2	5,2	8,2	64,4
12	170	22,2	5,2	5,2	8,5	84,6
13	178	24,1	5,8	5,8	8,8	96,6
14	190	26,4	6,0	6,0	9,2	108,9
15	200	27,7	6,1	6,1	9,7	130,4
16	205	29,2	7,0	7,0	10,3	149,3
17	225	31,0	7,0	7,0	10,8	183,9
18	236	32,0	7,3	7,3	11,0	201,7
19	248	33,0	8,3	8,2	12,2	237,3

## 雙搖頭棘輪扳手

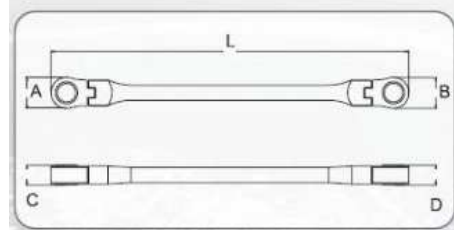
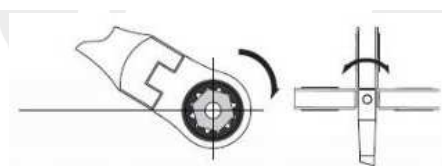

## CAR REPAIR

SIZE	L	A	B	C	D	G
8x10	236,6	15,4	18,8	7,4	8,8	221,6
10x11	294,0	18,8	21,3	8,8	9,2	317,2
10x12	294,0	18,8	21,3	8,8	9,2	317,2
11x13	329,7	21,3	26,8	9,2	10,1	401,7
12x14	329,7	21,3	26,8	9,2	10,1	401,7
13x15	369,9	26,8	28,4	10,1	11,6	638,8
14x17	369,9	26,8	28,4	10,1	11,6	638,8
16x18	411,6	28,4	31,0	11,6	13,0	640,4
17x19	411,6	28,4	31,0	11,6	13,0	640,4

# Wrench Series 扳手工具

## 短式棘輪扳手

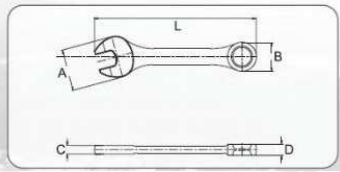
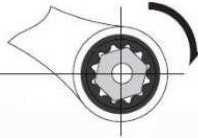

### CAR REPAIR

SIZE	L	A	B	C	D	G
8	89	17.3	18.0	4.6	7.5	30
9	92	18.9	18.6	5.3	8.5	37
10	96	21.4	21.4	5.5	8.5	44
11	104	23.7	22.9	5.6	8.8	54
12	107	26.0	24.0	6.0	9.0	62
13	109	27.9	25.9	6.2	10.0	75
14	116	30.2	28.5	6.7	10.4	92
15	120	32.1	30.1	7.5	11.4	113
16	124	34.0	31.0	7.5	11.5	120
17	129	36.4	32.9	8.0	12.0	143
18	132	38.0	33.9	8.3	12.2	147
19	140	40.5	35.8	9.1	13.4	191

## 加長型雙梅花扳手

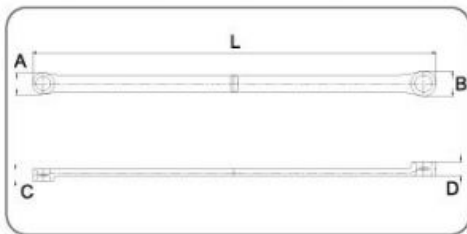

### CAR REPAIR

SIZE	L	A	B	C	D	G
8x10	235	12.5	15	7.5	8.4	72
10x11	291	14.3	17	8.5	9.5	95
10x12	291	14.3	17	8.5	9.5	95
11x13	328	17.8	20.3	10.4	11.3	157
12x14	328	17.8	20.3	10.4	11.3	157
13x15	368	20.2	23.3	11.5	13.2	217
14x17	368	20.2	23.3	11.5	13.2	217
16x18	407	23.7	26.6	13	14.8	284
17x19	407	23.7	26.6	13	14.8	284
19x21	415	27.5	29.7	13.46	14.39	376
22x24	430	31.3	34.0	15.4	17.7	482
8 x 10, B12 x 14, B14 x 17, B17 x 19						840

## LS特長扳手

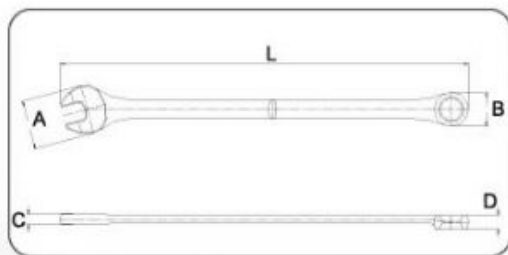

### CAR REPAIR

SIZE	L	A	B	C	D	G
10	189	22.8	15.8	5.1	6.9	53
11	207	24.6	17.3	5.3	7.0	62
12	225	27.2	18.8	5.6	7.8	77
13	243	28.6	20.4	5.7	8.5	113
14	261	31.4	21.8	6.9	9.1	128
15	279	33.5	23.4	7	9.3	144
16	297	35.3	24.8	7.3	10.0	182
17	314	37.6	26.2	7.4	10.1	197
18	333	39.4	27.5	7.8	11.3	223
19	349	41.5	28.7	8.7	12.7	271
10 11 12 13 14 15 16 17 18 19						1998

## 煙斗扳手

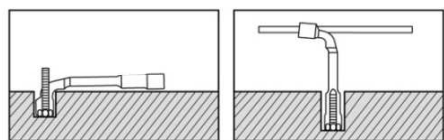
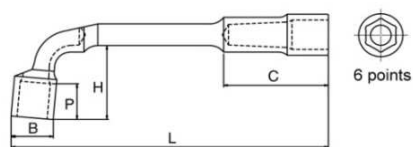

ITEN NO.	SIZE(mm)	B(mm)	P(mm)	H(mm)	C(mm)	L(mm)
HTW1500006L	6	10	7	15	29	110
HTW1500007L	7	11.5	8	15	30	114
HTW1500008L	8	12.5	10	20	32	120
HTW1500009L	9	14	10	20	33	125
HTW1500010L	10	15	11	20	35	131
HTW1500011L	11	16.5	12	20	37	137
HTW1500012L	12	17.5	12	25	40	144
HTW1500013L	13	19	14	25	47	152.5
HTW1500014L	14	20	14	30	48	160
HTW1500015L	15	21.5	15	35	50	174
HTW1500016L	16	22.5	17	35	54	185
HTW1500017L	17	24	18	35	56	197
HTW1500018L	18	25	19.5	40	58	211
HTW1500019L	19	26.5	20.5	40	62	218
HTW1500020L	20	27.5	21.5	45	63	222
HTW1500021L	21	29	23.5	45	65	231
HTW1500022L	22	30	23.5	45	67	247
HTW1500023L	23	31.5	24.5	45	74	255
HTW1500024L	24	32.5	24.5	45	77	266
HTW1500025L	25	34	24.5	50	79	278
HTW1500026L	26	35	25.5	50	80	289
HTW1500027L	27	36.5	27.5	55	84	299
HTW1500028L	28	37.5	27.5	55	86	310
HTW1500029L	29	39	28.5	65	93	319
HTW1500030L	30	40	28.5	65	93	332
HTW1500032L	32	42.5	28.5	65	95	353

## T型套筒

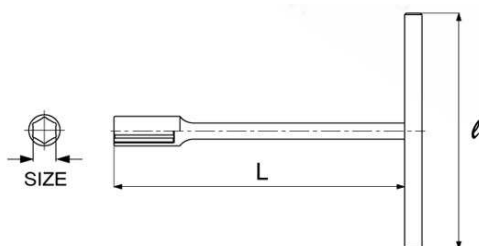

ITEN NO.	SIZE(mm)	l (mm)	L (mm)	weight(g ctn / pal)
HTW1400006T	6	120	190	53 10/40
HTW1400007T	7	120	190	73 10/40
HTW1400008T	8	200	300	212 10/40
HTW1400009T	9	200	300	307 10/40
HTW1400010T	10	200	300	317 10/40
HTW1400011T	11	200	300	327 10/40
HTW1400012T	12	200	300	328 10/40
HTW1400013T	13	200	300	333 10/40
HTW1400014T	14	200	300	345 10/40
HTW1400017T	17	250	300	602 6' 24



# Wrench Series 扳手工具

## 雙六角油管扳手

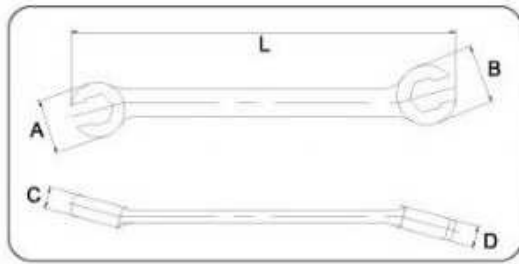

CONFORMS TO AMERICAN NATIONAL STANDARD INSTITUTE

SIZE	L	A	B	C	D	G
6 x 8	143	17.6	19.8	6.6	6.7	46
8 x 10	143	17.6	19.8	6.6	6.7	46
9 x 11	152	21.3	22.9	7.6	7.4	58
10 x 11	152	21.3	22.9	7.6	7.4	58
10 x 12	152	21.3	22.9	7.6	7.4	58
11 x 13	156	23.1	23.8	8.8	9.0	80
12 x 13	156	23.1	23.8	8.8	9.0	80
12 x 14	178	25.3	27.6	10.0	9.9	117
13 x 14	178	25.3	27.6	10.0	9.9	117
14 x 15	196	30.0	32.1	11.4	11.5	166
14 x 17	196	30.0	32.1	11.4	11.5	166
15 x 17	196	30.0	32.1	11.4	11.5	166
16 x 18	196	30.0	32.1	11.4	11.5	166
17 x 19	196	30.0	32.1	11.4	11.5	166
19 x 21	207	34.1	37.6	13.5	13.1	222
19 x 22	207	34.1	37.6	13.5	13.1	222
24 x 27	264	46.0	42.3	17.0	16.2	360
30 x 32	283	46.3	44.8	22.4	20.4	480
1/4 x 5/16	143	17.6	19.8	6.6	6.7	46
5/16 x 3/8	143	17.6	19.8	6.6	6.7	46
3/8 x 7/16	152	21.3	22.9	7.6	7.4	58
7/16 x 1/2	158	23.1	23.8	8.8	9.0	80
1/2 x 9/16	178	25.3	27.6	10.0	9.9	117
5/8 x 11/16	196	30.0	32.1	11.4	11.5	166
3/4 x 7/8	207	34.1	37.6	13.5	13.1	222

## 半月型扳手

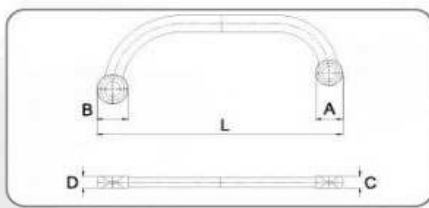
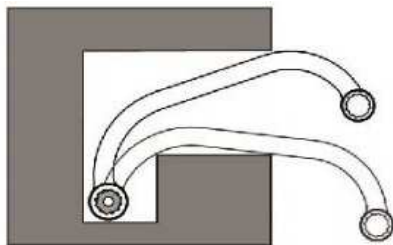

CONFORMS TO AMERICAN NATIONAL STANDARD INSTITUTE

SIZE	L	A	B	C	D	G
8 x 9	142	15.6	17.9	6.5	6.6	57
10 x 11	142	15.6	17.9	6.5	6.6	57
10 x 12	142	15.6	17.9	6.5	6.6	57
11 x 13	164	17.9	20.7	8.0	8.2	90
12 x 13	164	17.9	20.7	8.0	8.2	90
12 x 14	164	17.9	20.7	8.0	8.2	90
13 x 15	190	21.4	25.1	8.2	9.2	133
14 x 15	190	21.4	25.1	8.2	9.2	133
14 x 16	190	21.4	25.1	8.2	9.2	133
14 x 17	190	21.4	25.1	8.2	9.2	133
15 x 17	216	24.8	27.7	8.8	9.6	166
16 x 18	216	24.8	27.7	8.8	9.6	166
17 x 19	216	24.8	27.7	8.8	9.6	166
18 x 19	255	27.6	33.0	10.0	11.1	244
19 x 21	255	27.6	33.0	10.0	11.1	244
19 x 22	255	27.6	33.0	10.0	11.1	244
5/16 x 3/8	142	15.6	17.9	6.5	6.6	57
3/8 x 7/16	142	15.6	17.9	6.5	6.6	57
7/16 x 1/2	164	17.9	20.7	8.0	8.2	90
9/16 x 5/8	190	21.4	25.1	8.2	9.2	133
11/16 x 3/4	216	24.8	27.7	8.8	9.6	166
13/16 x 7/8	255	27.6	33.0	10.0	11.1	244

**ABERLA**<sup>®</sup>

[www.aberlatools.com](http://www.aberlatools.com)

[www.abest-tools.com](http://www.abest-tools.com)